

Advanced Operating Systems
MS degree in Computer Engineering
University of Rome Tor Vergata 
Lecturer: Francesco Quaglia

Kernel programming basics

- Addressing schemes and software protection models
- Hardware/software protection support
- Kernel access GATEs
- Per-CPU/per-thread memory
- System call dispatching
- Case study: LINUX (Kernels 2.4/2.6/3.xx/4.xx)

Linear addressing

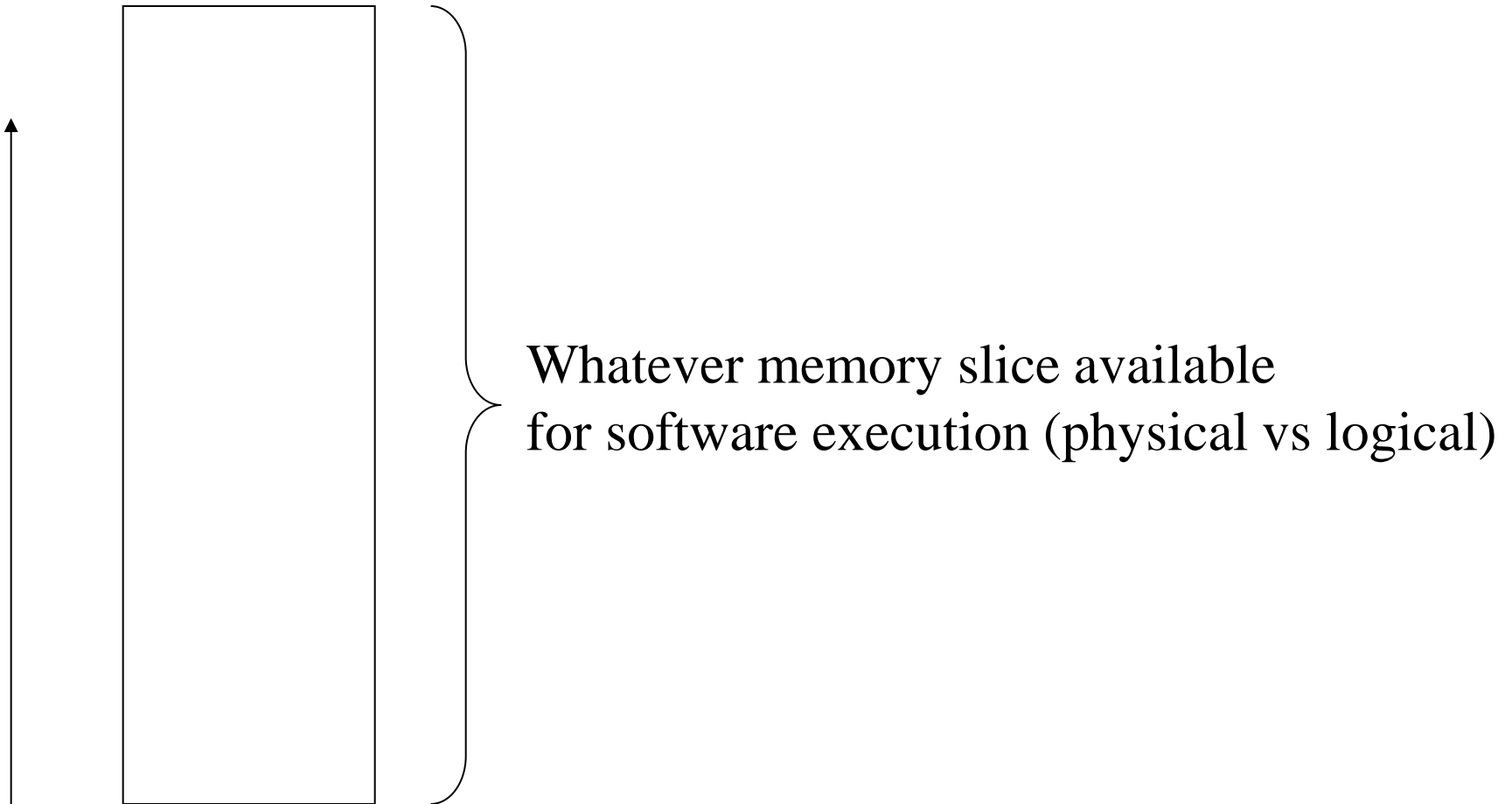

Linear address (<offset>)

Segmentation

Address space (a linear one)

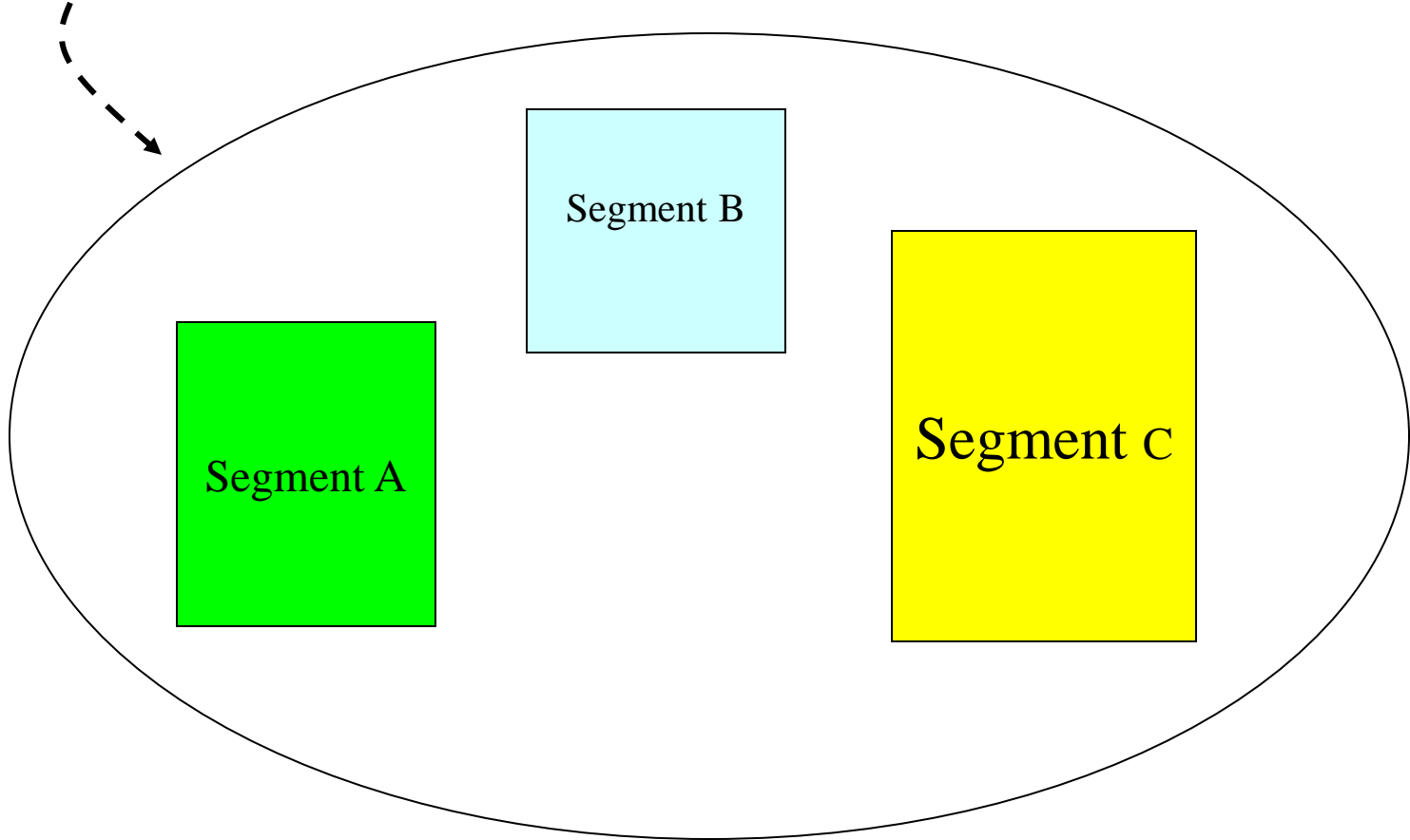

address = <seg.id,offset> (es. <A,0x10)

Combining segments in a linear address space

Address specification = $\langle \text{seg.id}, \text{offset} \rangle$ (es. $\langle \text{B}, \text{offset} \rangle$)

Need to know where B is located in the linear address space (this is the “base” of B)

Then the linear address is $\langle \text{base} + \text{offset} \rangle$

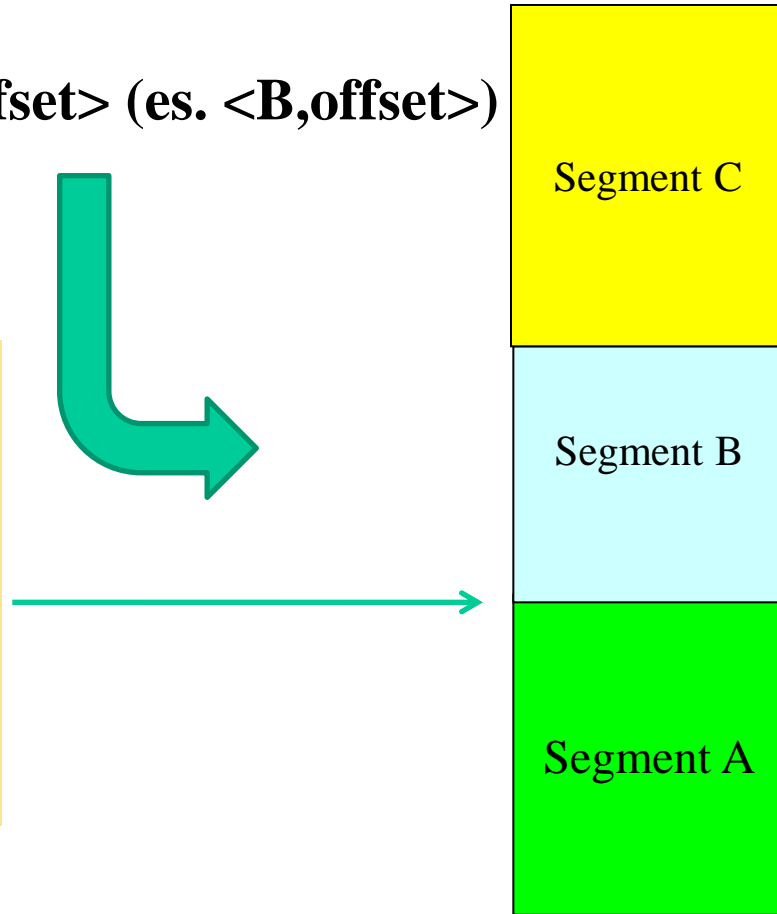

Virtual memory

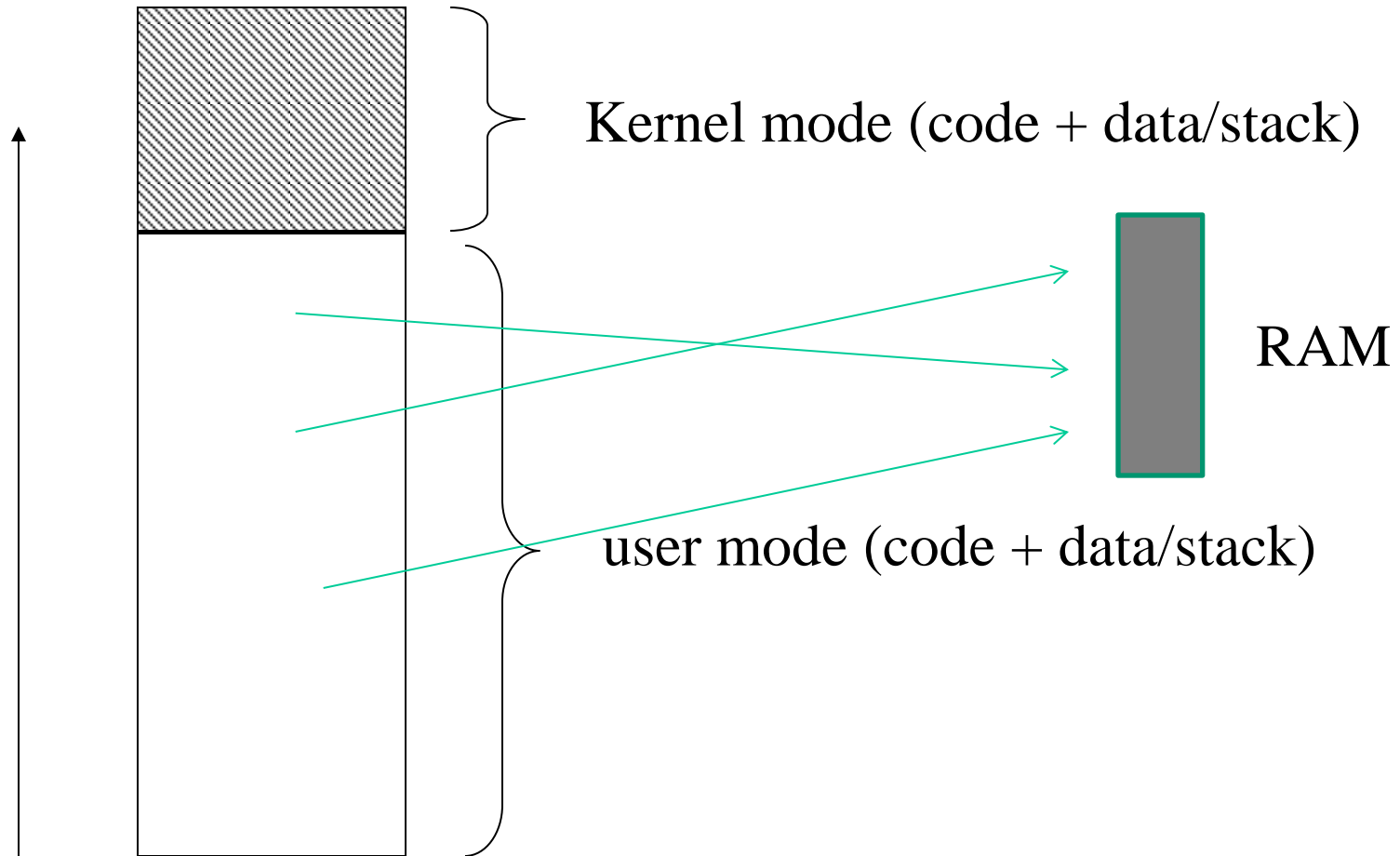

Linear addressing + mapping to actual storage (if existing)

Segmentation based addresses

- Code relies on **addresses** formed by **<segment number, offset>**
- If segment numbers are not specified by the machine instruction, some default segment is used for each target datum (instruction or operand)
- Modern processors (system processors) are equipped such in a way to support segmentation efficiently, in combination with linear addressing and virtual memory (say paging)
- The whole architecture is therefore requested to handle a complex address mapping scheme such as
segmented addr \Rightarrow linear addr \Rightarrow paged addr \Rightarrow physical addr

A very base x86 example

```
mov  (%rax), %rbx  
push %rbx
```



We might not imagine it but, when running this piece of code our x86 processor is implicitly using 3 different segments of memory!!

To have an exact idea of what is going on along program flow (in terms of reflection on the hardware usage) we need to know such segmentation related details

“System” processors vs segmentation

- “system” processors (those oriented to host operating system software) rely on hardware components that allow **fast and transparent access to segmentation information (e.g. segment specific information)**
- These are
 - CPU registers
 - Main memory tables (directly pointed by registers)

Segmentation with paging



- both are logical addresses
- the offset value may differ

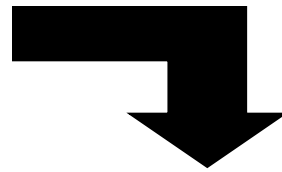
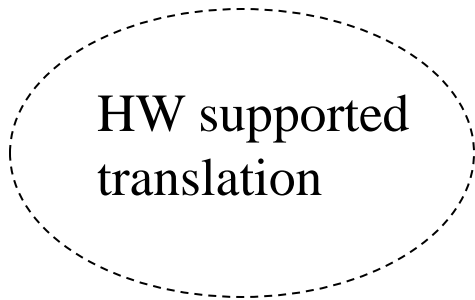

Determination of the linear address relying on $\langle \text{base}, \text{offset} \rangle$

2-level paging example

x86 memory access modes

- Real mode

- ✓ Offers backward compatibility towards 286!!
- ✓ a 16-bit segment register keeps the target segment ID
- ✓ 16-bit (general) registers keep the segment offset
- ✓ Targeted addresses are physical, and are computed as

$$\text{PhysicalAddress} = \text{Segment} * 16 + \text{Offset}$$

- ✓ Around 1MB (2^{20}B) of memory is allowed
- ✓ Minimal support for separating chunks of memory in the addressing scheme
- ✓ No segment specific protection information!!
- ✓ Not suited for modern software systems!!!

x86 memory access modes

- 80386 protected mode

- ✓ a 16-bit segment register keeps the target segment ID (using 13 bits)
- ✓ 32-bit (general) registers keep the segment offset
- ✓ The base of the segment in linear addressing is kept into a table in memory
- ✓ Targeted addresses are linear and are computed as
$$\text{address} = \text{TABLE}[\text{segment}].\text{base} + \text{offset}$$
- ✓ Up to 4GB of linear (either physical or logical) memory is allowed
- ✓ 3-bit for control (protection) are kept in the segment register
much better for OS software!!!

x86 memory access modes

- Long mode (x86-64)

- ✓ a 16-bit segment register keeps the target segment ID (using 13 bits)
- ✓ 64-bit (general) registers keep the segment offset (limited to 48-bit global addressing in canonical form)
- ✓ The base of the segment in linear addressing is kept into a table in memory
- ✓ Targeted addresses are linear and are computed as
$$\text{address} = \text{TABLE}[\text{segment}].\text{base} + \text{offset}$$
- ✓ Up to 2^{48} B (256 TB) of linear memory is allowed
- ✓ 3-bit for control (protection) are kept in the segment register

x86 segment tables

- There are two table types keeping segments information: **Global Descriptor Table (GDT)** and **Local Descriptor Table (LDT)**
- Typically GDT and LDT are kept in main memory, and are directly accessible via pointers maintained by CPU registers
- GDT determines the mapping of linear addresses at least for kernel mode (namely kernel level segments) ... nowadays it is the unique used segment table in most operating systems
- LDT determines the mapping of linear addresses for user mode (namely user level segments), if not done via GDT
- These addresses are then used to access physical memory via page tables (if paging is activated)

GDT organization

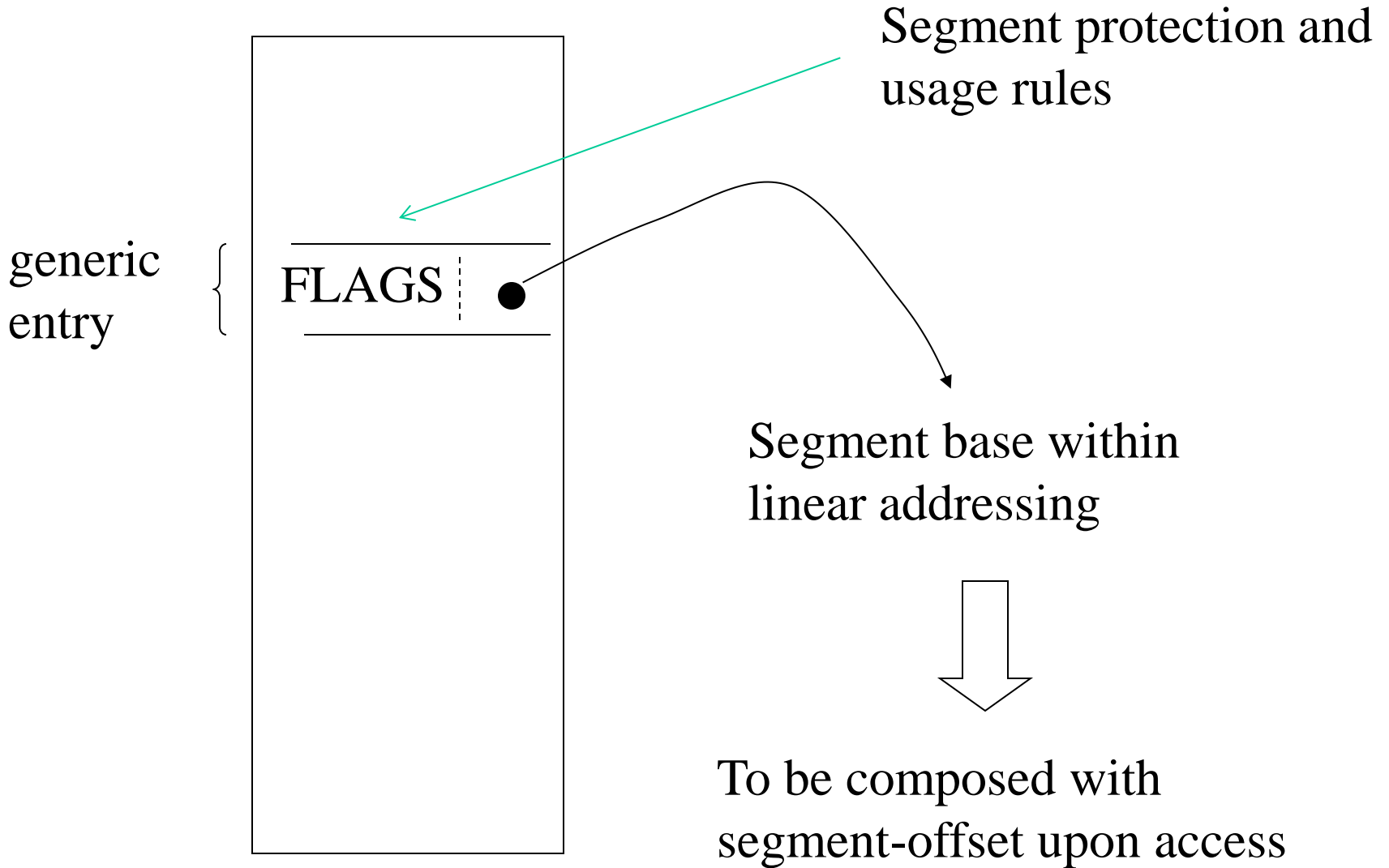

Segmentation vs paging

- Segmentation and paging typically have different targets
- Segmentation is a classical means for **protecting code and data**
- This protection mechanism is generally based on **coarse grain schemes** (in fact, segments may have very large sizes, covering up to the whole address space for the application)
- Paging (possibly coupled with virtual memory techniques) is generally employed as a means for **improving physical-memory management efficiency**
- Such “efficiency oriented” mechanism is based on a **fine-grain approach**, namely it relies on the size of the page frame for the specific hardware architecture (e.g. 4KB or 2/4MB for x86 architectures)

Segmentation vs multi-cores/multi-threading

- ... we know that paging schemes are still able to enforce protection of memory (via control bits in page-table entries)
- So we may think that segmentation is somehow useless in modern software systems
- This is a wrong concept, since as we will show segmentation still plays a central role in multi-core architectures
- It also plays a central role in multi-thread programming
- in 1985 paging was already there in the hardware but Intel further extended the segmentation support (e.g. in the 80386 processor)
- although the segmentation logic has been significantly revised in x86-64 processors

The x86-64 revision

- Registers keeping track of segment IDs (also known as selectors) are not all managed the same way by firmware on board of the processor
- For some registers keeping segment IDs (hence for the corresponding segments in the GDT table) a fixed base of 0x0 is enforced for the segments
- Protection bits in the segment table entries associated with those segments IDs still work
- For a few registers keeping segment IDs the classical rule relying on arbitrary base values for the segments is adopted

Segmentation based protection model (i)

- Each segment is associated with a given **protection level (or privilege level)**
- Each routine having protection level h can invoke any other routine having protection level h , within any segment (**this can be achieved via intra-segment and cross-segment jumps**)
- Routines having protection level h can invoke routines having protection level different from h via **cross-segment jumps**
- **Cross-segment jumps always allow** jumping from protection level h to protection level $h+i$
- Each segment having protection level h is associated with a set of access points, called GATEs, each one identified as $\langle seg.id, offset \rangle$
- Any GATE is associated with a maximum level $max=h+j$ starting from which the GATE can be passed through

Segmentation based protection model (ii)

- If $level(S)=h$ and $max(GATE(S))=h+i$ then segment S **entails a GATE** for accessing level h for modules associated with protection level up to $h+i$
- Cross-segment jumps deny the access to the destination if the source operates at protection level greater than the maximum one associated with the gate
- Overall, cross-segment jumps deny the access to the destination anytime we do not use a GATE as the destination *entry* for the jump

Protection levels and jumps: the ring model

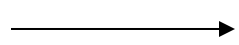
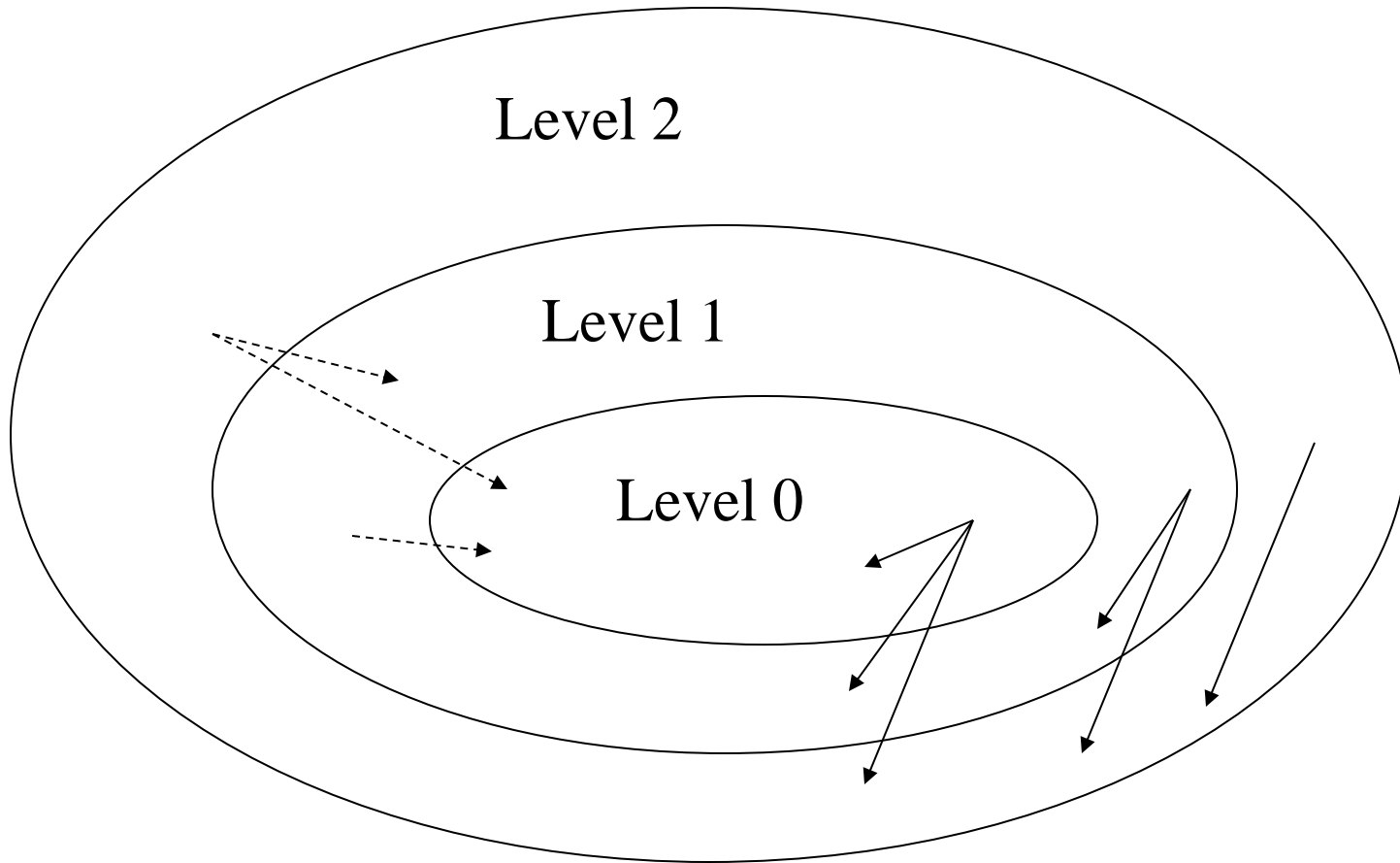

Always admitted

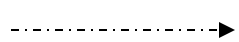

Admitted depending on the *max* origin level associated with the target GATE

An example

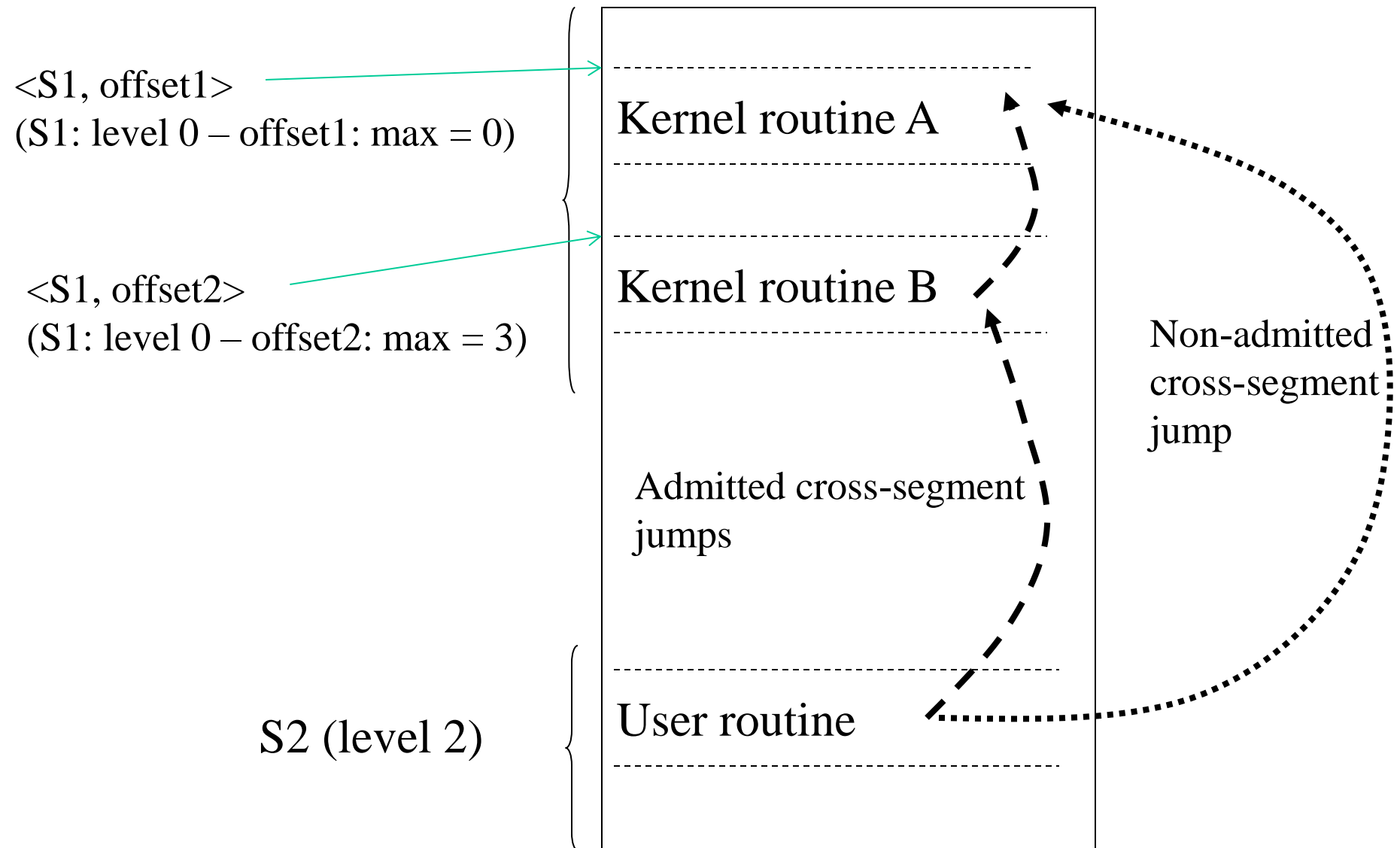

Objectives of protection levels

- Denial of uncontrolled access to kernel level modules
- Kernel level access is controlled via specific “entry points” (the GATEs), which are explicitly used as destinations for jumps (more generally control flow variations) originated while running at worse protection levels
- In conventional operating systems, the entry points are typically associated with:
 - **interrupt handlers** (asynchronous invocations)
 - **software traps** (synchronous invocations)

Ring scheme for x86 machines

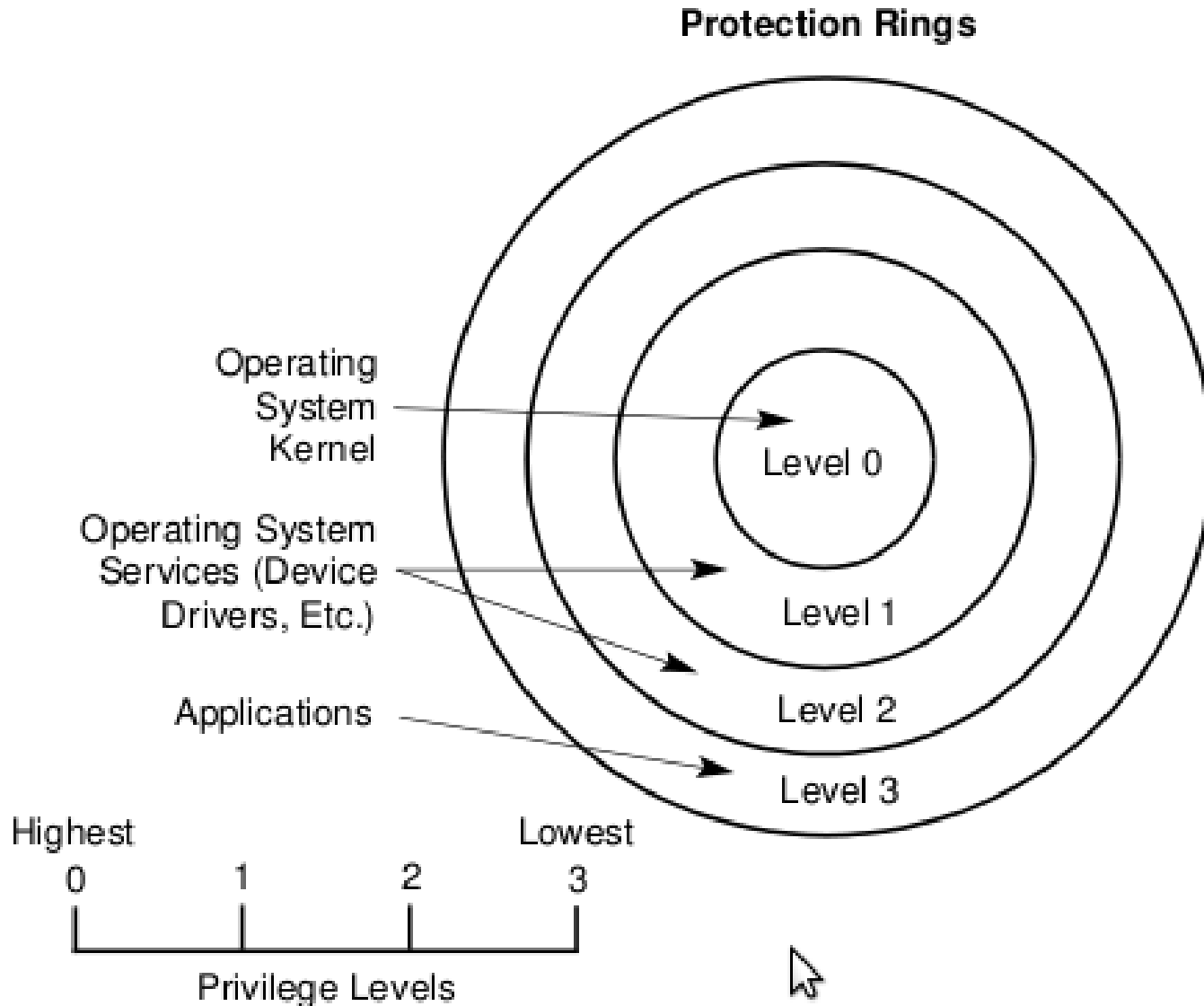

x86 address composition with segmentation

- An address does not specify the segment ID directly
- It can specify a segment-selector register
- This register keeps information on the actual segment to which we are accessing
- An example:

`<segment-selector-register, displacement>`

x86 details on the segmentation support

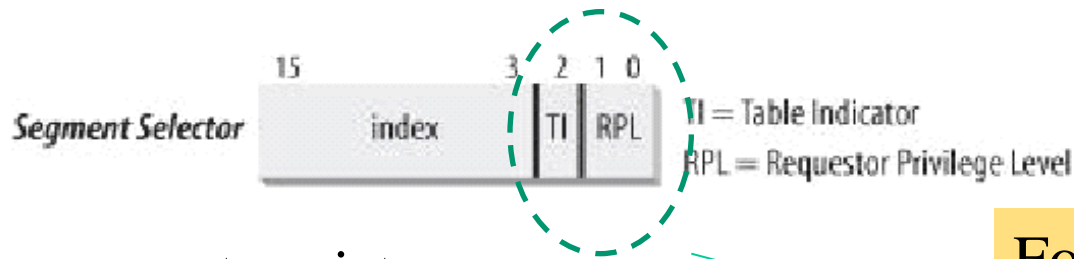

CS: code segment register

SS: stack segment register

DS: data segment register

ES: data segment register

FS: data segment register

GS: data segment register

added in
80386

For CS RPL is
called **CPL**

This register is only
writable by control
flow variation
instructions

- **CS (Code Segment Register)** points to the current segment. The 2 lsb identify the CPL (Current Privilege Level) for the CPU (from 0 to 3).
- **SS (Stack Segment Register)** points to the segment for the current stack.
- **DS (Data Segment Register)** points to the segment containing static and global data.

Back to the very early x86 example

```
mov  (%rax), %rbx  
push %rbx
```

Here we are seamlessly (say implicitly) using CS, and DS for the first instruction and CS and SS for the second instruction

ES is an additional (to DS) implicit segment for specific classes of machine instructions, e.g. string-targeted ones like `stos` and `movs`

x86 GDT entries (segment descriptors)

31				16				15				0							
Base 0:15								Limit 0:15											
63		56		55		52		51		48		47		40		39		32	
Base 24:31				Flags		Limit 16:19		Access Byte				Base 16:23							

This directly supports protected mode

Access byte content:

Pr - Present bit. This must be **1** for all valid selectors.

Privl - Privilege, 2 bits. Contains the ring level (0 to 3)

Ex - Executable bit (**1** if code in this segment can be executed)

.....

Flags:

Gr - Granularity bit. If **0** the limit is in 1 B blocks (byte granularity),
if **1** the limit is in 4 KB blocks (page granularity)

....

Accessing GDT entries

- Given that a *segment descriptor* is 8 bytes in size, its relative address within GDT is computed by multiplying the 13 bits of the *index* field of *segment selector* by 8
- E.g, in case GDT is located at address 0x00020000 (value that is kept by the **gdt register**) and the *index* value within *segment selector* is set to the value 2, the address associated with the *segment descriptor* is $0x00020000 + (2*8)$, namely 0x00020010

This is not only a pointer but actually a packed struct describing positioning and size of the GDT

Store Global Descriptor Table Register

Opcode	Mnemonic	Description
0F 01 /0	SGDT m	Store GDTR to m.

Description

Stores the content of the global descriptor table register (GDTR) in the destination operand. The destination operand specifies a 6-byte memory location. If the operand-size attribute is 32 bits, the 16-bit limit field of the register is stored in the low 2 bytes of the memory location and the 32-bit base address is stored in the high 4 bytes. If the operand-size attribute is 16 bits, the limit is stored in the low 2 bytes and the 24-bit base address is stored in the third, fourth, and fifth byte, with the sixth byte filled with 0s.

SGDT is only useful in operating-system software; however, it can be used in application programs without causing an exception to be generated. See "LGDT/LIDT-Load Global/Interrupt Descriptor Table Register" in Chapter 3 for information on loading the GDTR and IDTR.

Operation

```
if(OperandSize == 16) {  
    Destination[0..15] = GDTR.Limit;  
    Destination[16..39] = GDTR.Base; //24 bits of base address loaded  
    Destination[40..47] = 0;  
}  
else { //32-bit Operand Size  
    Destination[0..15] = GDTR.Limit;  
    Destination[16..47] = GDTR.Base; //full 32-bit base address loaded  
}
```

IA-32 Architecture Compatibility

The 16-bit form of the SGDT is compatible with the Intel 286 processor if the upper 8 bits are not referenced. The Intel 286 processor fills these bits with 1s; the Pentium 4, Intel Xeon, P6 family, Pentium, Intel486, and Intel386 processors fill these bits with 0s.

x86 long mode provides 2 (the table size) + 8 (the table address) bytes

Example code

```
#include <stdio.h>

struct desc_ptr {
    unsigned short size;
    unsigned long address;
} __attribute__((packed)) ;

#define store_gdt(ptr) asm volatile("sgdt %0":"=m"(*ptr))

int main (int argc, char**argv){
    struct desc_ptr gdtptr;
    char v[10]; //another way to see 10 bytes packed in memory

    store_gdt(&gdtptr);
    store_gdt(v);

    printf("comparison is %d\n", memcmp(v, &gdtptr, 10));
    printf("GDTR is at %x - size is %d\n", gdtptr.address, gdtptr.size);
    printf("GDTR is at %x - size is %d\n", ((struct desc_ptr*)v)->address,
           ((struct desc_ptr*)v)->size);
}
```

Access scheme

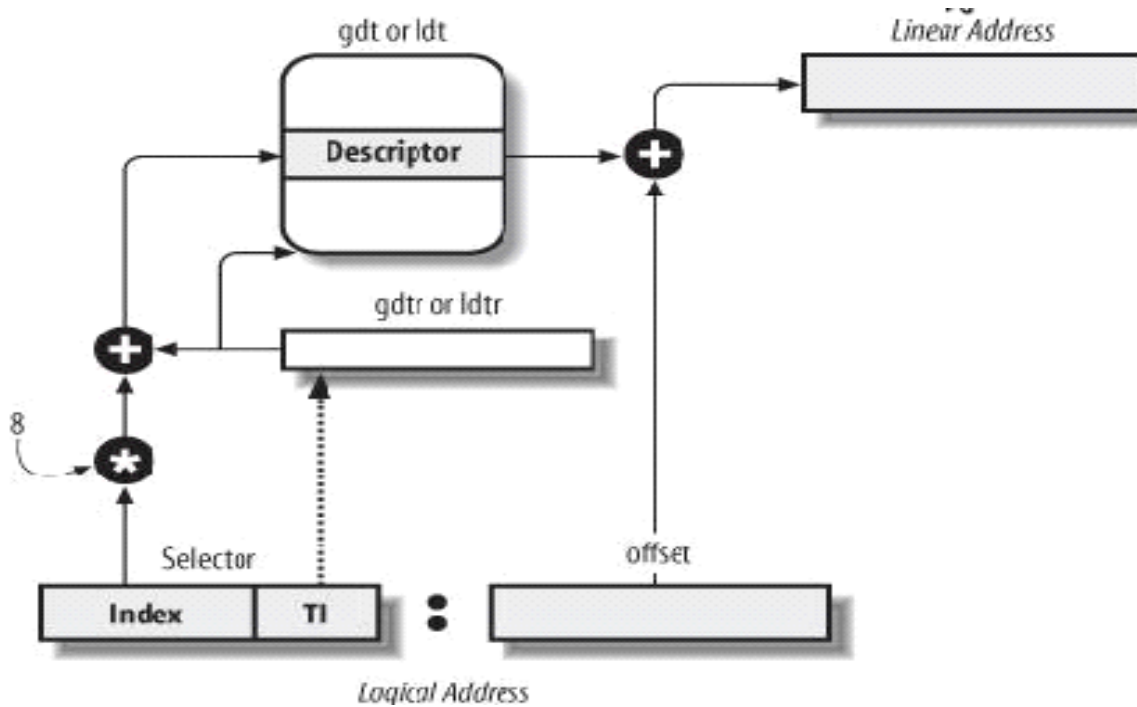

Caching of descriptors
(1 cache register per segment
selector – non-programmable)

Cache line filled upon selector
update

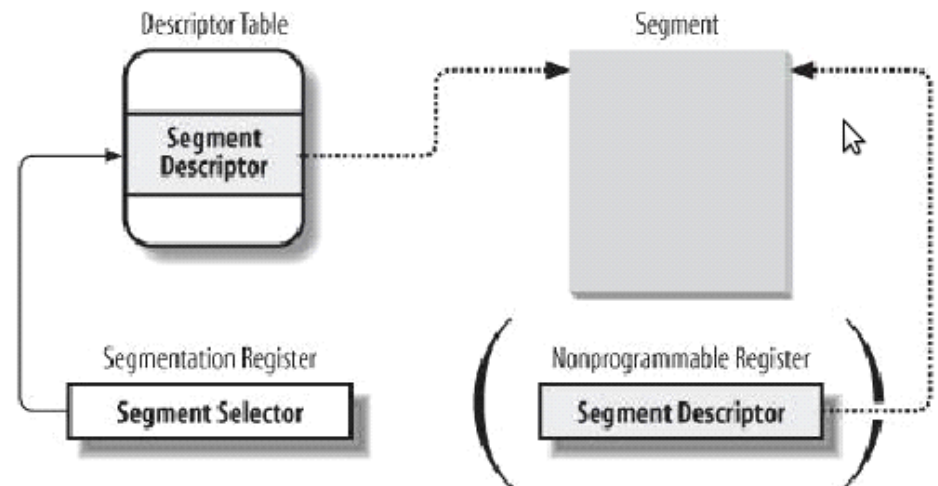

Making explicit usage of segments while coding

```
#include <stdio.h>

#define load(ptr,var) asm volatile("mov %%ds:(%0), %%rax"::"a" (var):"a" (ptr))
#define store(val,ptr) asm volatile("push %%rbx; mov %0, %%ds:(%1); pop %%rbx" \
::"a" (val), "b" (ptr):)

int main (int argc, char**argv){

    unsigned long x = 16;

    unsigned long y;

    load(&x,y);
    printf("variable y has value %u\n",y);

    store(y+1,&x);
    printf("variable x has value %u\n",x);

}
```

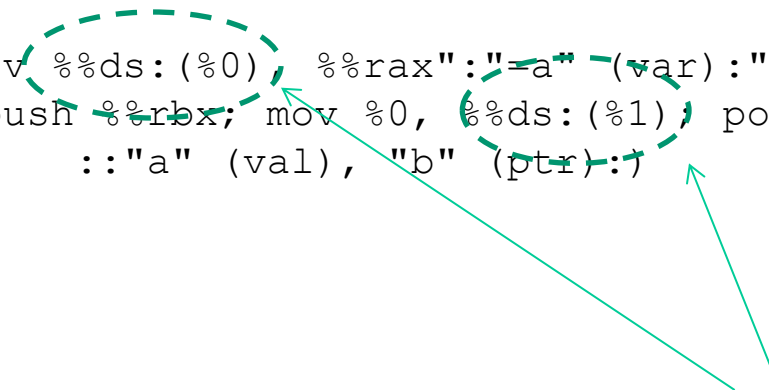

explicit reference
to the data segment
register (DS)

Code/data segments for LINUX

Segment	Base	G	Limit	S	Type	DPL	D/B	P
user code	0x00000000	1	0xffff	1	10	3	1	1
user data	0x00000000	1	0xffff	1	2	3	1	1
kernel code	0x00000000	1	0xffff	1	10	0	1	1
kernel data	0x00000000	1	0xffff	1	2	0	1	1

Can we read/write/execute?

Is the segment present?

x86-64 directly forces base to 0x0 for the corresponding segment registers

x86-64 selector management details

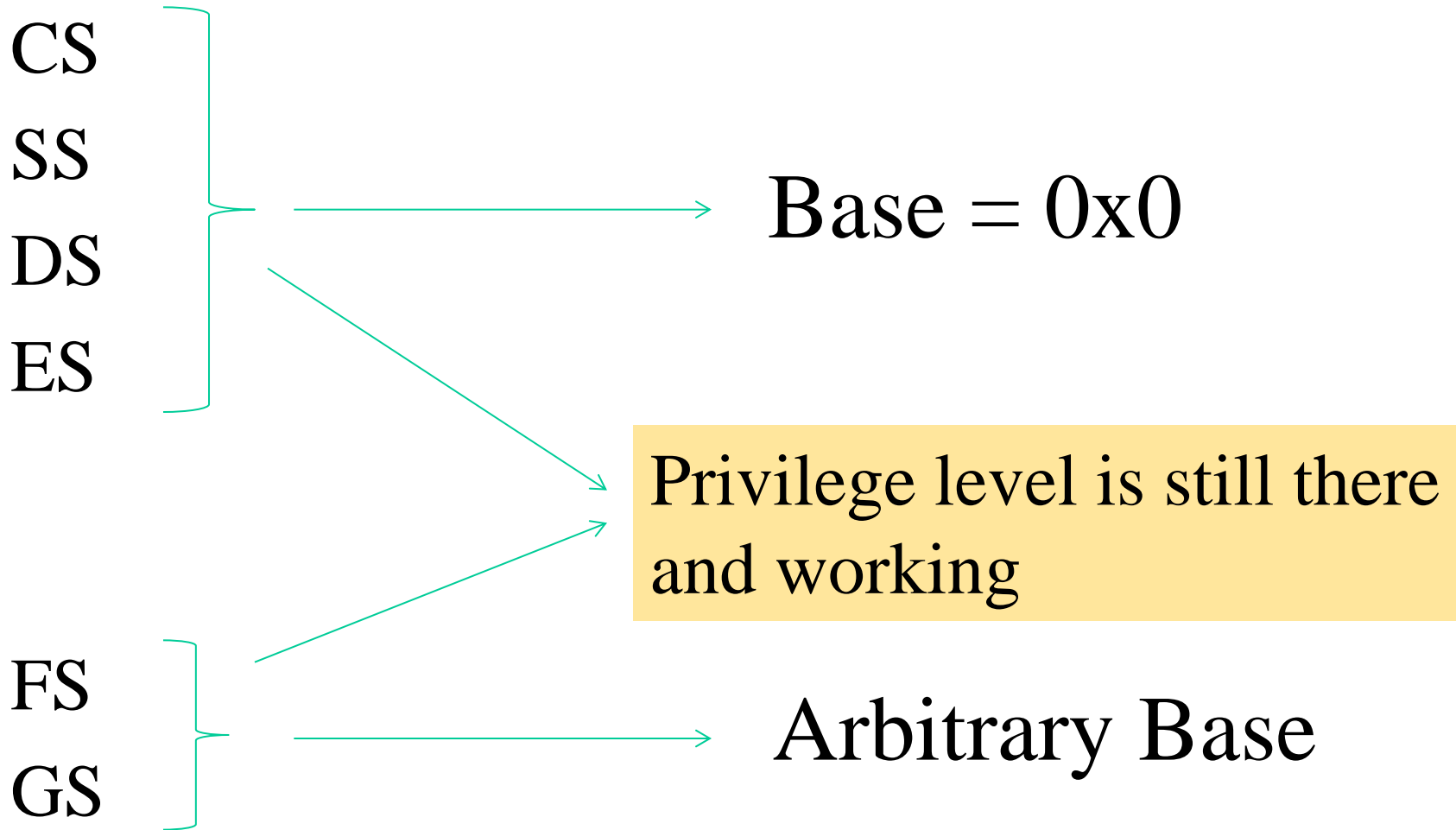

Segment selectors update rules

- CS plays a central role, since it keeps the CPL (Current Privilege level)
- CS is only updated via control flow variations
- All the other segment registers can be updated if the segment descriptor they would point to after the update has $DPL \geq CPL$
- Clearly, **with CPL = 0 we can update everything (ring 0 has no limit)**

LINUX GDT on x86

Beware these

<i>Linux's GDT</i>	<i>Segment Selectors</i>
null	0x0
reserved	
reserved	
reserved	
not used	
not used	
TLS #1	0x33
TLS #2	0x3b
TLS #3	0x43
reserved	
reserved	
reserved	
kernel code	0x60 (<code>__KERNEL_CS</code>)
kernel data	0x68 (<code>__KERNEL_DS</code>)
user code	0x73 (<code>__USER_CS</code>)
user data	0x7b (<code>__USER_DS</code>)

<i>Linux's GDT</i>	<i>Segment Selectors</i>
TSS	0x80
LDT	0x88
PNPBIOS 32-bit code	0x90
PNPBIOS 16-bit code	0x98
PNPBIOS 16-bit data	0xa0
PNPBIOS 16-bit data	0xa8
PNPBIOS 16-bit data	0xb0
APMBIOS 32-bit code	0xb8
APMBIOS 16-bit code	0xc0
APMBIOS data	0xc8
not used	
not used	
not used	
not used	
not used	
double fault TSS	0xf8

TSS

- TSS (Task State Segment): the set of linear addresses associated with TSS is a subset of the linear address space destined to kernel data segment
- each TSS (one per CPU-core) is kept within the **int_tss** array
- the *Base* field within the *n*-th core TSS register points to the *n*-th entry of the **int_tss** array (transparently via the TSS segment)
- $Gr=0$ while *limit is 104 * 4 bytes*
- $DPL=0$, since the TSS segment cannot be accessed in user mode

x86 TSS structure

31		15		0		
I/O Map Base Address				T	100	
		LDT Segment Selector			96	
		GS			92	
		FS			88	
		DS			84	
		SS			80	
		CS			76	
		ES			72	
EDI					68	
ESI					64	
EBP					60	
ESP					56	
EBX					52	
EDX					48	
ECX					44	
EAX					40	
EFLAGS					36	
EIP					32	
CR3 (PDBR)					28	
		SS2			24	
ESP2					20	
		SS1			16	
ESP1					12	
		SS0			8	
ESP0					4	
		Previous Task Link			0	

 Reserved bits. Set to 0.

Although it could be ideally used for hardware based context switches, it is not in Linux/x86

It is essentially used for privilege level switches (e.g. access to kernel mode), based on stack differentiation

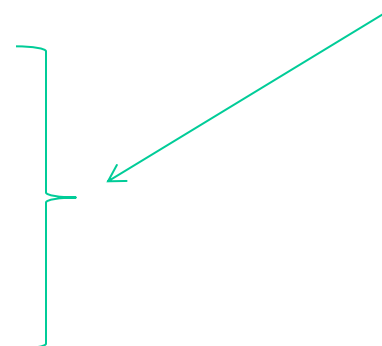

x86-64 variant

offset	31-16	15-0
0x00	reserved	
0x04	RSP0 (low)	
0x08	RSP0 (high)	
0x0C	RSP1 (low)	
0x10	RSP1 (high)	
0x14	RSP2 (low)	
0x18	RSP2 (high)	



room for 64-bit
stack pointers has been created
sacrificing general registers
snapshots

Loading the TSS register

- x86 ISA (Instruction Set Architecture) offers the instruction `LTR`
- This is privileged and must be executed at $CPL = 0$
- The TSS descriptor must be filled with a source operand
- The source can be a general-purpose register or a memory location
- Its value (16 bits) keeps the index of the TSS descriptor into the GDT

LTR — Load Task Register

Opcode	Instruction	Op/En	64-Bit Mode	Compat/Leg Mode	Description
0F 00 /3	LTR <i>r/m16</i>	M	Valid	Valid	Load <i>r/m16</i> into task register.

Instruction Operand Encoding ¶

Op/En	Operand 1	Operand 2	Operand 3	Operand 4
M	ModRM: <i>r/m</i> (<i>r</i>)	NA	NA	NA

Description ¶

Loads the source operand into the segment selector field of the task register. The source operand (a general-purpose register or a memory location) contains a segment selector that points to a task state segment (TSS). After the segment selector is loaded in the task register, the processor uses the segment selector to locate the segment descriptor for the TSS in the global descriptor table (GDT). It then loads the segment limit and base address for the TSS from the segment descriptor into the task register. The task pointed to by the task register is marked busy, but a switch to the task does not occur.

The LTR instruction is provided for use in operating-system software; it should not be used in application programs. It can only be executed in protected mode when the CPL is 0. It is commonly used in initialization code to establish the first task to be executed.

The operand-size attribute has no effect on this instruction.

GDT replication

- By the discussion on TSS we might have already observed that different CPU-cores in a multi-core/multi-processor system may need to fill a given entry of the GDT with different values
- To achieve this goal the GDT is actually replicated in common operating systems, with one copy for each CPU-core
- Then each copy slightly diverges in a few entries
- The main (combined) motivations are
 - ✓ performance
 - ✓ transparency of data access separation

Actual architectural scheme

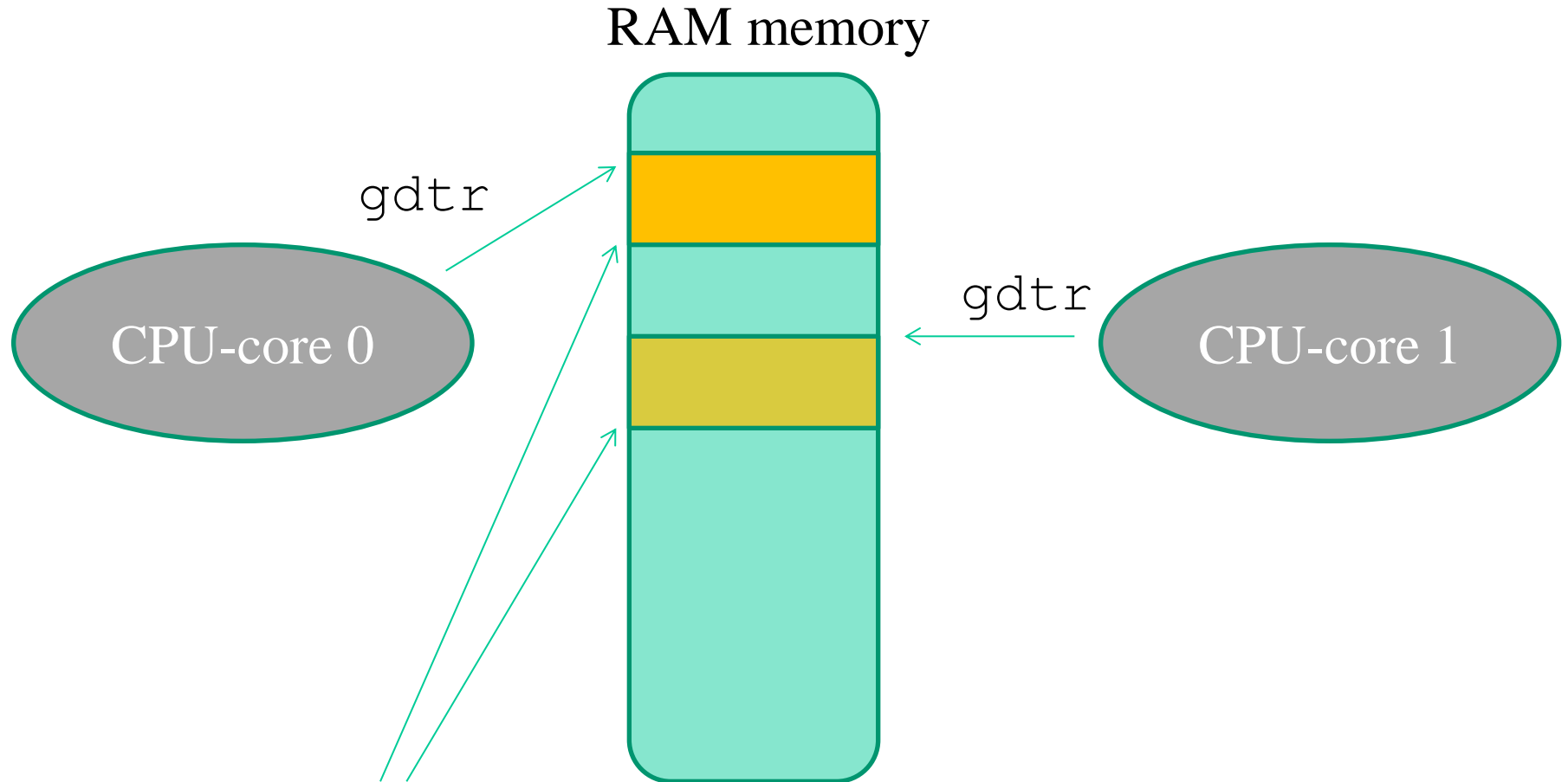

The two tables may differ in a few entries!!

Replication benefits: per-CPU seamless memory accesses

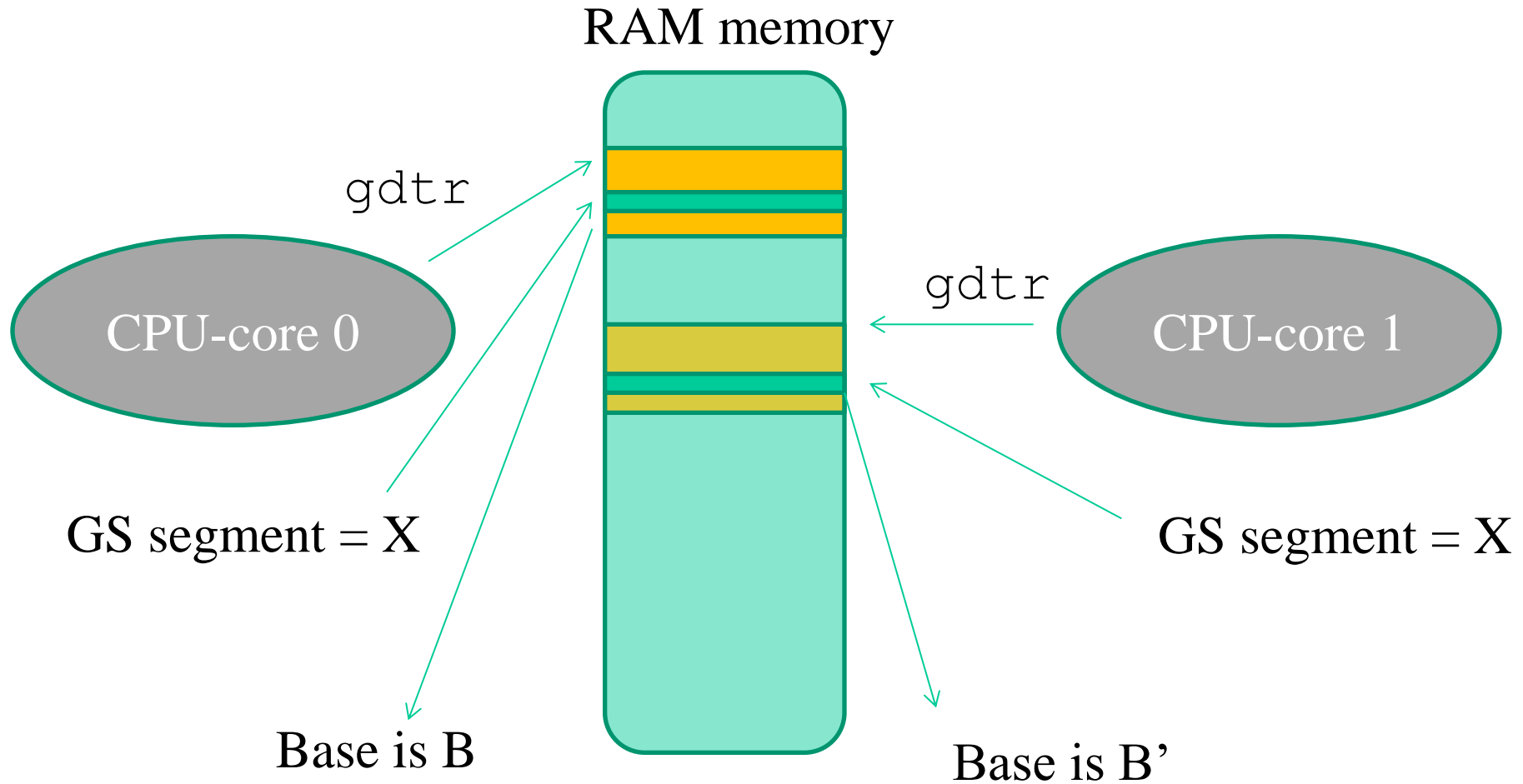

Same displacement within segment X seamlessly leads the two CPU-cores to access different linear addresses

Per-CPU memory

- No need for a CPU-core to call, e.g. CUID (... devastating for the speculative pipeline ...) to determine what memory portion is explicitly dedicated to it
- Fast access via GS segment displacing for per-CPU common operations such as
 - ✓ Statistics update (non need for LOCKED CMPXCHG)
 - ✓ Fast control operations

Per-CPU memory setup in Linux

- Based on some per-CPU reserved zone in the linear addressing scheme
- The reserved zone is displaced by relying on the GS segment register
- Based on macros that select a displacement in the GS segment
- Based on macros that implement memory access relying on the selected displacement

An example

```
DEFINE_PER_CPU(int, x);
```

```
int z;
```

```
z = this_cpu_read(x);
```

The above statement results in a single instruction:

```
mov ax, gs:[x]
```

To operate with no special define we can also get the actual address of the per-CPU data and work normally:

```
y = this_cpu_ptr(&x)
```

TLS – Thread Local Storage

- It is based on setting up different segments associated with FS and GS selectors
- Each time a thread is CPU-dispatched, kernel software restores its corresponding segment descriptors into TLS#1, TLS#2 and TLS#3 within the GDT
- We have system calls allowing us to change the segment descriptors to be posted on TLS entries

Segment management system calls (i)

NAME [top](#)

`arch_prctl` - set architecture-specific thread state

SYNOPSIS [top](#)

```
#include <asm/prctl.h>
#include <sys/prctl.h>

int arch_prctl(int code, unsigned long addr);
int arch_prctl(int code, unsigned long *addr);
```

DESCRIPTION [top](#)

`arch_prctl()` sets architecture-specific process or thread state. *code* selects a subfunction and passes argument *addr* to it; *addr* is interpreted as either an *unsigned long* for the "set" operations, or as an *unsigned long **, for the "get" operations.

Subfunctions for x86-64 are:

Segment management system calls (ii)

Subfunctions for x86-64 are:

ARCH_SET_FS

Set the 64-bit base for the *FS* register to *addr*.

ARCH_GET_FS

Return the 64-bit base value for the *FS* register of the current thread in the *unsigned long* pointed to by *addr*.

ARCH_SET_GS

Set the 64-bit base for the *GS* register to *addr*.

ARCH_GET_GS

Return the 64-bit base value for the *GS* register of the current thread in the *unsigned long* pointed to by *addr*.

RETURN VALUE [top](#)

On success, **arch_prctl()** returns 0; on error, -1 is returned, and *errno* is set to indicate the error.

x86-64 control registers

- CR0-CR3 or CR0-CR4 (on more modern x86 CPUs)
- CR0: is the baseline one
- CR1: is reserved
- CR2: keeps the linear address in case of a fault
- CR3: is the page-table pointer

CR0 structure vs long mode

Long mode uses a combination of this and the EFER (Extended Feature Enable Register) MSR (model specific register)

Bit	Name	Full Name	Description
0	PE	Protected Mode Enable	If 1, system is in protected mode, else system is in real mode
1	MP	Monitor co-processor	Controls interaction of WAIT/FWAIT instructions with TS flag in CR0
2	EM	Emulation	If set, no x87 FPU is present, if clear, x87 FPU is present
3	TS	Task switched	Allows saving x87 task context upon a task switch only after x87 instruction used
4	ET	Extension type	On the 386, it allowed to specify whether the external math coprocessor was an 80287 or 80387
5	NE	Numeric error	Enable internal x87 floating point error reporting when set, else enables PC style x87 error detection
16	WP	Write protect	When set, the CPU can't write to read-only pages when privilege level is 0
18	AM	Alignment mask	Alignment check enabled if AM set, AC flag (in EFLAGS register) set, and privilege level is 3
29	NW	Not-write through	Globally enables/disable write-through caching
30	CD	Cache disable	Globally enables/disable the memory cache
31	PG	Paging	If 1, enable paging and use the CR3 register, else disable paging

Interrupts/traps vs kernel access

- Interrupts are **asynchronous events** that are not correlated with the current CPU-core execution flow
- Interrupts are generated by external devices, and can be masked (vs non-masked)
- Traps, also known as **exceptions**, are **synchronous events**, strictly coupled with the current CPU-core execution (e.g. division by zero)
- Multiple executions of the same program, under the same input, may (but not necessarily do) give rise to the same exceptions
- Traps are (actually have been historically) used as the mechanism for on demand access to kernel mode (via system calls)

Management of trap/interrupt events

- The kernel keeps a **trap/interrupt table**
- Each table entry keeps a **GATE descriptor**, which provides information on the address associated with the GATE (e.g. <seg.id,offset>) and the GATE protection level
- The content of the trap/interrupt table is exploited to determine whether the access to the GATE can be enabled
- The check relies on the current content of CPU registers, the segment registers, which specify the current privilege level (CPL)
- In principle, it may occur that a given GATE **is described within multiple entries** of the trap/interrupt table (aliasing), possibly with different protection specifications

Summary on x86 control flow variations

- **intra-segment**: standard jump instruction (e.g. JMP <displacement> on x86 architectures)
 - firmware only verifies whether the displacement is within the current segment boundary
- **cross-segment**: long jump instructions (e.g. LJMP <seg.id>, <displacement> on x86 architectures)
 - Firmware verifies whether jump is enabled on the basis of privilege levels (no CPL improvement is admitted)
 - Then, firmware checks whether the displacement is within the segment boundaries
- **cross-segment via GATEs**: trap instructions (e.g. INT <table displacement> on x86 architectures)
 - Firmware checks whether jumping is admitted depending on the privilege level associated with the target GATE as specified within the **trap/interrupt table**

An overview

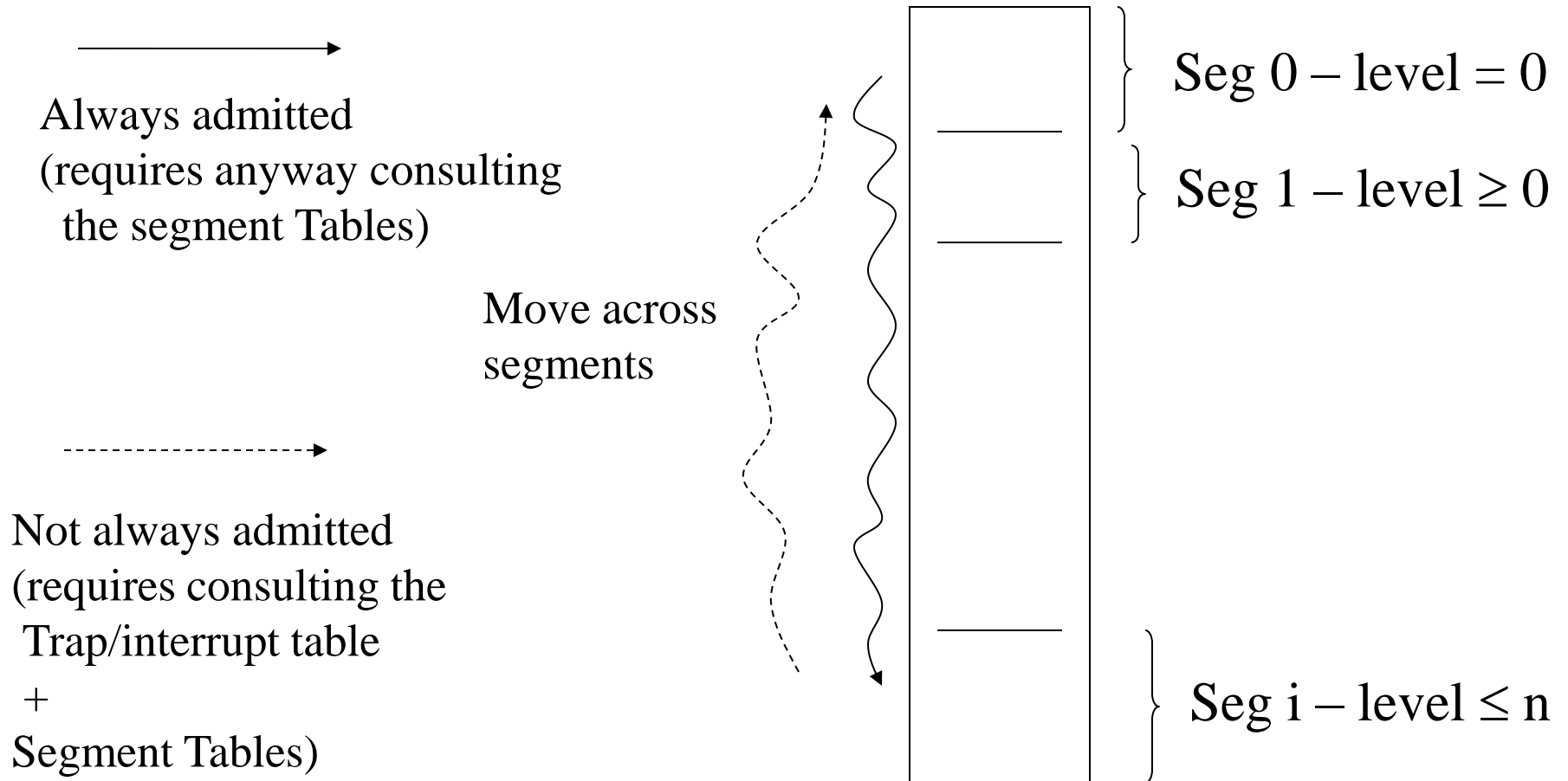

GATE details for the x86 architecture (i)

- The trap/interrupt table is called **Interrupt Descriptor Table (IDT)**
- Any entry keeps
 - The ID of the target segment and the segment displacement
 - the *max* level starting from which the access to the GATE is granted
- IDT is accessible via the `idt_r` register which is a packed structure keeping the linear address of the IDT and the size (number of entries, each made up by 8 or 16 bytes, depending on whether extended 64-bit mode is active)
- The register is loadable via the LIDT machine instruction

GATE details for the x86 architecture (ii)

- We know the **current privilege level** is kept within CS
- If protection information enables jumping, the segment ID within IDT is used to access GDT in order to check whether jumping is within the segment boundaries
- If check succeeds the current privilege level gets updated
- The new value is taken from the **corresponding entry** of GDT (this value corresponds to the privilege level of the target segment)
- The GATE description also tells whether the activated code is interruptible or not

Conventional operating systems

- For LINUX/Windows systems, the GATE for on-demand access (via software traps) to the kernel **is unique**
- For i386 machines the corresponding software traps are
 - INT 0x80 for LINUX (with backward compatibility in x86-64)
 - INT 0x2E for Windows
- Any other GATE is reserved for the management of run-time errors (e.g. divide by zero exceptions) and interrupts
- They are not usable for on-demand access via software (clearly except if you hack the kernel)
- The software module associated with the on-demand access GATE implements **a dispatcher that is able to trigger the activation of the specific system call** targeted by the application

Data structures for system call dispatching

- There exists a “**system call table**” that keeps, in any entry, the address of a specific system call
- Such an address becomes the target for a subroutine activation by the dispatcher
- To access the correct entry, the dispatcher gets in input the **number (the numerical code) of the target system call** (typically this input is provided within a CPU register)
- The code is used to identify the target entry within the system call table
- Then the dispatcher invokes the system call routine (as a “jump sub-routine” – CALL instruction on x86)
- The actual system call, once executed, provides its output (return) value within a CPU register

The trap-based dispatching scheme

User level

define input and
access GATE (trap)

retrieve system call
return value

Kernel level

system call
activation

System call
code

System call table

dispatcher

return from
trap

retrieve the reference to
the system call code

User space return

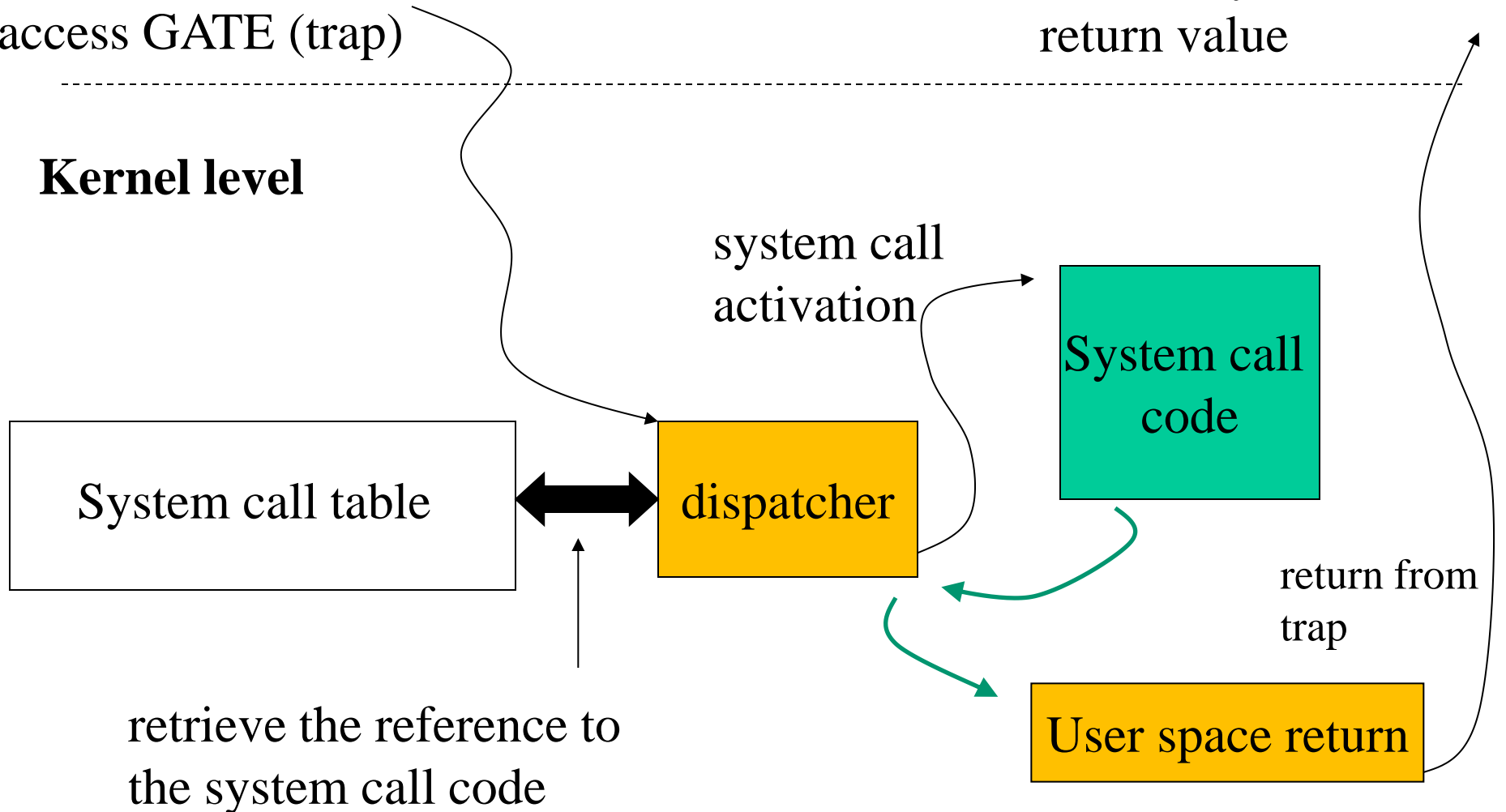

Trap vs interruptible execution

- Differently from interrupts, **trap** management is typically configured so as not to entail/enable automatically resetting the interruptible-state for the CPU-core
- Any critical code portion associated with the management of the trap within the kernel requires explicit set of the interruptible-state bit, and the reset after job is complete (e.g. via CLI e STI instructions in x86 processors)
- For SMP/multi-core machines this **may not suffice** for guaranteeing correctness (e.g. atomicity) while handling the trap
- To address this issue, spinlock mechanisms are adopted, which are base on atomic **test-end-set code portions** (e.g., generated via the x86 LOCK prefix on standard compilation tool chains)

Test-and-set support

- Modern instruction sets offer a single instruction to atomically test-and-set memory, this is the CAS (Compare And Swap) instruction
- On x86 machines the actual CAS is called CMPXCHG (Compare And Exchange)
- ... but we already discussed of this while dealing with memory consistency!!

System call software components

- User side: software module (a) providing the input parameters to the GATE (and to the actual system call) (b) activating the GATE and (c) recovering the system call return value
- kernel side:
 - dispatcher
 - system call table
 - actual system call code
- Addition of a new **system call** means working on both sides
- Typically, this happens with no intervention on the dispatcher **in all the cases where the system call format is compliant with those predefined for the target operating system**

Linux along our path

- Kernel 2.4 : highly oriented to expansibility modifiability
- Kernel 2.6: more scalable
- Kernel 3.x: more structured and secure
- Kernel 4.x: even more secure

LINUX system calls support:
path starting from kernel 2.4 –
lasting up to kernel 4.17

Predefined system call formats: the classical 2.4 way

- Macros for standard system call formats are in `include/asm-xx/unistd.h` (or `asm/unistd.h`)
- Here we can find:
 - **Numerical codes associated with system calls (as seen by user level software)**, hence displacement values within the system call table at kernel side
 - **The standard formats for the user level module triggering acces to the system GATE** (namely the module that activates the system call dispatcher), each for a different value of the number of system call parameters (from 0 to 6)
- Essentially the above file contains **ASM vs C directives** and architecture specific compilation directives
- This file represents a meeting point between ANSI-C programming and machine specific ASM language (in relation to the GATE access functionality)

System call numerical codes – 2.4.20

```
/*
 * This file contains the system call numbers.
 */

#define __NR_exit 1
#define __NR_fork 2
#define __NR_read 3
#define __NR_write 4
#define __NR_open 5
#define __NR_close 6
#define __NR_waitpid 7
#define __NR_creat 8
#define __NR_link 9
#define __NR_unlink 10
#define __NR_execve 11
#define __NR_chdir 12
.....
#define __NR_fallocate 324
```

User level tasks for accessing the gate GATE

1. **Specification of the input parameters via CPU registers** (note that these include the actual system call parameters and the dispatcher ones)
2. ASM instructions triggering the GATE (e.g. traps)
3. Recovery of the return value of the systems call (upon returning from the trap associated with GATE activation)

Code block for a standard system call with no parameter (e.g. fork())

```
#define __syscall0(type,name) \  
type name(void) \  
{ \  
long __res; \  
__asm__ volatile ("int $0x80" \  
: "=a" (__res) \  
: "0" (__NR_##name)); \  
__syscall_return(type, __res); \  
}
```

Assembler instructions

Tasks to be done after the execution of the assembler code block

Tasks preceding the assembler code block

Managing the return value and errno

```
/* user-visible error numbers are in the range -1 - -124:
   see <asm-i386/errno.h> */

#define __syscall_return(type, res) \
do { \
    if ((unsigned long)(res) >= (unsigned long)(-125)) { \
        errno = -(res); \
        res = -1; \
    } \
    return (type) (res); \
} while (0)
```

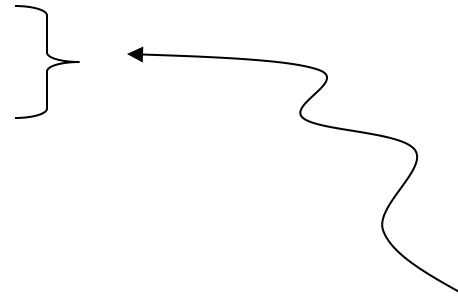

Case of `res` within the interval `[-1, -124]`

Note: why the do/while(0) construct?

It is a C construct that allows to

- #define a multi-statement operation
- put a semicolon after and
- still use within an **if** statement

Code block for a standard system call with one parameter (e.g. close())

```
#define __syscall1(type, name, type1, arg1) \
type name(type1 arg1) \
{ \
long __res; \
__asm__ volatile ("int $0x80" \
: "=a" (__res) \
: "0" (__NR_##name), "b" ((long) (arg1))); \
__syscall_return(type, __res); \
}
```

2 registers used for the input



Code block for a system call with six parameters (max admitted by the standard) – i386 case

```
#define __syscall6(type,name,type1,arg1,type2,arg2,type3,arg3,type4,arg4, \
 \
    type5,arg5,type6,arg6) \
type name (type1 arg1,type2 arg2,type3 arg3,type4 arg4,type5 arg5,type6 \
arg6) \
{ \
long __res; \
__asm__ volatile ("push %%ebp ; movl %%eax,%%ebp ; movl %1,%%eax ; int \
$0x80 ; pop %%ebp" \
    : "=a" (__res) \
    : "i" (__NR_##name), "b" ((long)(arg1)), "c" ((long)(arg2)), \
    "d" ((long)(arg3)), "S" ((long)(arg4)), "D" ((long)(arg5)), \
    "0" ((long)(arg6))); \
__syscall_return(type,__res); \
}
```

We use 4 general purpose registers (eax,ebx,ecx,edx) plus the additional registers ESI e EDI, and the ebp register (**base pointer** for the current stack frame, which is saved before overwriting) and a local integer variable “i”

i386 calling conventions for system calls

```
/*
 *      0 (%esp) - %ebx      ARGS
 *      4 (%esp) - %ecx
 *      8 (%esp) - %edx
 *     C (%esp) - %esi
 *     10 (%esp) - %edi
 *     14 (%esp) - %ebp      END ARGS
 *     18 (%esp) - %eax
 *     1C (%esp) - %ds
 *     20 (%esp) - %es
 *     24 (%esp) - orig_eax
 *     28 (%esp) - %eip
 *     2C (%esp) - %cs
 *     30 (%esp) - %eflags
 *     34 (%esp) - %oldesp
 *     38 (%esp) - %oldss
 */
```

The stack layout representation complies with the traditional stack based passage of parameters



Ring and baseline CPU state information (firmware saved onto the system stack)

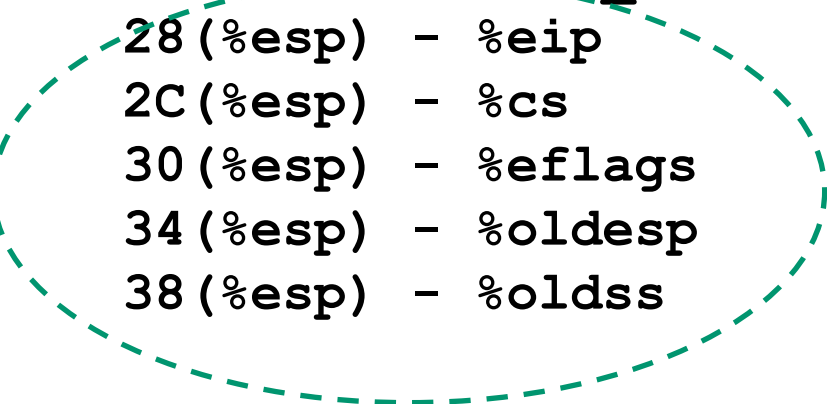
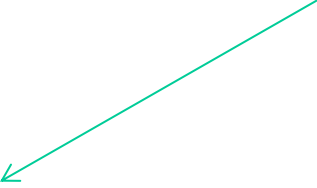

x86-64 calling conventions for system calls

```
/*  
 * Register setup:  
 * rax  system call number  
 * rdi  arg0  
 * rcx  return address for syscall/sysret, C arg3  
 * rsi  arg1  
 * rdx  arg2  
 * r10  arg3 (--> moved to rcx for C)  
 * r8   arg4  
 * r9   arg5  
 * r11  eflags for syscall/sysret, temporary for C  
 * r12-r15,rbp,rbx saved by C code, not touched.  
 *  
 * Interrupts are off on entry.  
 * Only called from user space.  
 */
```

x86-64 system call re-indexing

- x86-64 Linux has re-indexed the system calls available in the kernel
- A new table of defines describes the codes associated with these system calls
- Such a table is available to user code programmers via:

```
/local/include/linux/asm-x86/unistd_64.h
```

- However both the two different indexing mechanisms still work we will see how they can co-exist in a while!!

Details on passing parameters

- Once gained control, the dispatcher will take a complete snapshot of CPU registers
- The snapshot is taken within the **system level stack**
- **Then the dispatcher will invoke the system call as a subroutine call** (e.g. via a CALL instruction in x86 architectures)
- The actual system call will retrieve the parameters according to the ABI
- The taken snapshot can be modified upon the system call return (e.g. for delivering the return value)

An example

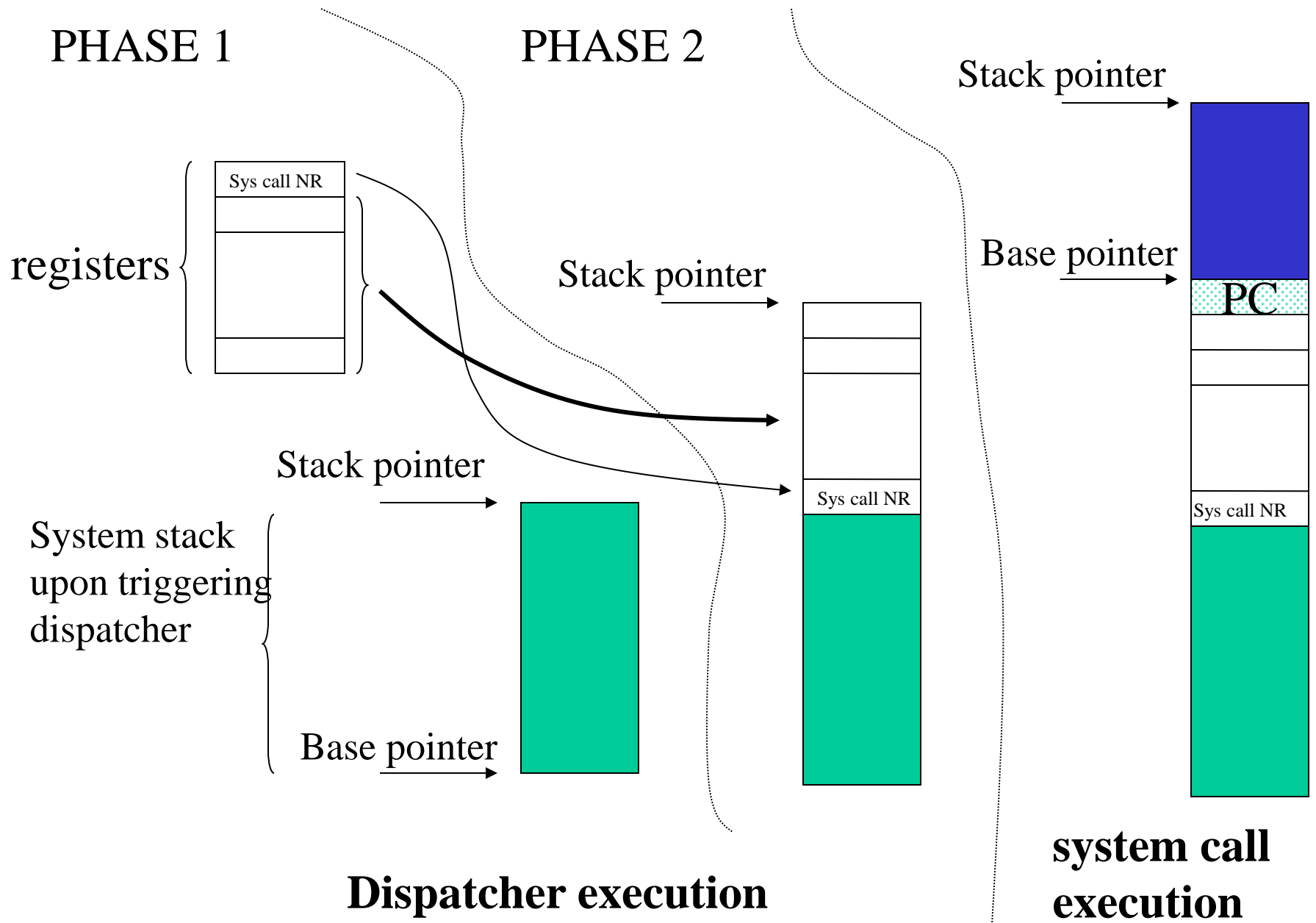

i386 stack alignment

```
struct pt_regs {  
    unsigned long bx;  
    unsigned long cx;  
    unsigned long dx;  
    unsigned long si;  
    unsigned long di;  
    unsigned long bp;  
    unsigned long ax;  
    unsigned short ds;  
    unsigned short __dsh;  
    unsigned short es;  
    unsigned short __esh;  
    unsigned short fs;  
    unsigned short __fsh;  
    unsigned short gs;  
    unsigned short __gsh;  
    unsigned long orig_ax;  
    unsigned long ip;  
    unsigned short cs;  
    unsigned short __csh;  
    unsigned long flags;  
    unsigned long sp;  
    unsigned short ss;  
    unsigned short __ssh;  
}
```

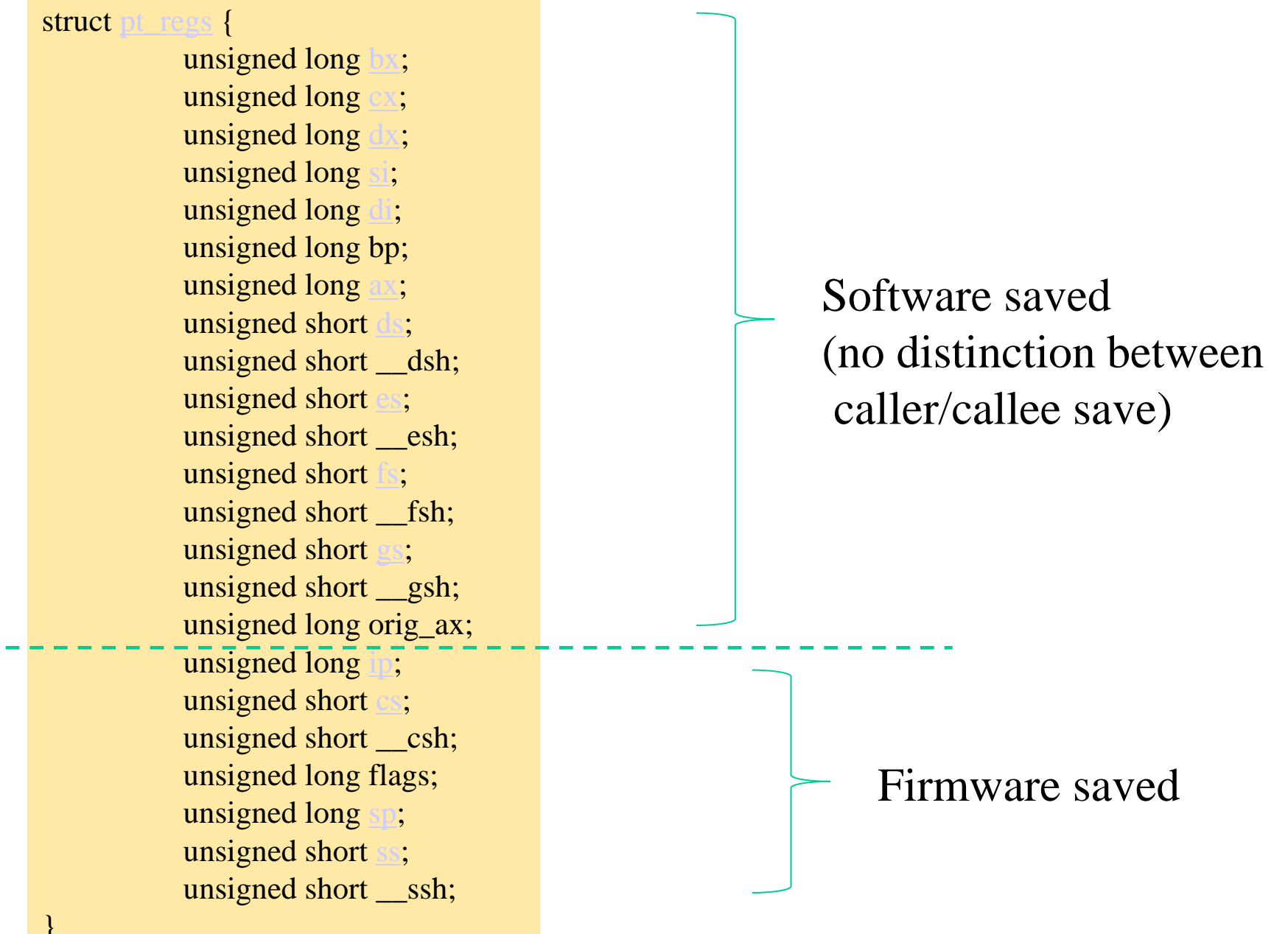

Software saved
(no distinction between
caller/callee save)

Firmware saved

x86-64 stack alignment

```
struct pt_regs {
    /* * C ABI says these regs are callee-preserved. They aren't saved on
kernel entry * unless syscall needs a complete, fully filled "struct pt_regs". */
    unsigned long r15;    unsigned long r14; unsigned long r13;
    unsigned long r12;    unsigned long bp;  unsigned long bx;
/* These regs are callee-clobbered. Always saved on kernel entry. */
    unsigned long r11;
    unsigned long r10;
    unsigned long r9;
    unsigned long r8;
    unsigned long ax;
    unsigned long cx;
    unsigned long dx;
    unsigned long si; unsigned long di;
/* * On syscall entry, this is syscall#. On CPU exception, this is error code. * On
hw interrupt, it's IRQ number: */
    unsigned long orig_ax;
/* Return frame for iretq */
    unsigned long ip;
    unsigned long cs;
    unsigned long flags;
    unsigned long sp;
    unsigned long ss;
    /* top of stack page */
};
```



Firmware managed

Simple examples for adding system calls to the user API

Provide a C file which:

- includes `unistd.h`
 - contains the definition of the numerical codes for the new system calls
 - contains the macro-definition for creating the actual standard module associated with the new system calls (e.g. `_syscall0()`)
-

```
#include <unistd.h>
#define _NR_my_first_sys_call 254
#define _NR_my_second_sys_call 255

_syscall0(int,my_first_sys_call);
_syscall1(int,my_second_sys_call,int,arg);
```

Limitations

- The system call table has a maximum number of entries (resizing requires reshuffling the whole kernel compilation process ... why? Let's discuss the issue by face)
- A few entries are free, and can be used for adding new system calls
- With Kernel 2.4.25:
 - The maximum number of entries is specified by the macro `#define _NR_syscalls 270`
 - This is defined within the file `include/linux/sys.h`
 - As specified by `include/asm-i386/unistd.h`, the available system call numerical codes start at the value 253
 - Hence the available code interval (with no modification of the table size) is in between 253 and 269

An example for gcc version 3.3.3 (SuSE Linux)

```
#include <stdio.h>
#include <asm/unistd.h>
#include <errno.h>

#define __NR_pippo 256

_syscall0(void,pippo);

main() {
    pippo();
}
```

Overriding the `fork ()` i386 system call

```
#include <unistd.h>

#define __NR_my_fork 2 //same numerical code as the original
#define _new_syscall0(name) \
int name(void) \
{ \
    asm("int $0x80" : : "a" (__NR_##my_fork) ); \
    return 0; \
} \

_new_syscall0(my_fork)

int main(int a, char** b){
    my_fork();
    pause(); // there will be two processes pausing !!
}
```

“int 0x80” system call path performance implications

- One memory access to the IDT
- One memory access to the GDT to retrieve the kernel CS segment
- One memory access to the GDT (namely the TSS) to retrieve the kernel level stack pointer
- A lot of clock cycles waiting for data coming from memory (just to control the execution flow)
- Asymmetric delays in asymmetric hardware (e.g. NUMA)
- Unreliable outcome for time-interval measures using system calls, see `gettimeofday()` (and *rdtsc*)

The x86 revolution (starting with Pentium3)

- CS value for kernel code cached into an apposite MSR (Model Specific Register)
- Kernel entry point offset (the target EIP/RIP) kept into an MSR
- Kernel level stack/data base kept into an MSR
- Entering kernel code is as easy as flushing the MSRs values onto the corresponding original registers (e.g. CS, DS, SS recall that the corresponding bases are defaulted to 0x0)
- No memory access for activating the system call dispatcher
- **This is the fast system call path!!**

Fast system call path additional details

SYSENTER instruction for 32 bits - SYSCALL instruction for 64 bits

based on (pseudo) register manipulation

- CS register set to the value of (SYSENTER_CS_MSR)
- EIP register set to the value of (SYSENTER_EIP_MSR)
- SS register set to the sum of (8 plus the value in SYSENTER_CS_MSR)
- ESP register set to the value of (SYSENTER_ESP_MSR)

SYSEXIT instruction for 32 bits - SYSRET instruction for 64 bits

based on pseudo register manipulation

- CS register set to the sum of (16 plus the value in SYSENTER_CS_MSR)
- EIP register set to the value contained in the EDX register
- SS register set to the sum of (24 plus the value in SYSENTER_CS_MSR)
- ESP register set to the value contained in the ECX register

MSR and their setup

/usr/src/linux/include/asm/msr.h:

```
101 #define MSR_IA32_SYSENTER_CS 0x174
```

```
102 #define MSR_IA32_SYSENTER_ESP 0x175
```

```
103 #define MSR_IA32_SYSENTER_EIP 0x176
```

/usr/src/linux/arch/i386/kernel/sysenter.c:

```
36 wrmsr(MSR_IA32_SYSENTER_CS, __KERNEL_CS, 0);
```

```
37 wrmsr(MSR_IA32_SYSENTER_ESP, tss->esp1, 0);
```

```
38 wrmsr(MSR_IA32_SYSENTER_EIP,  
        (unsigned long) sysenter_entry, 0);
```

rdmsr and **wrmsr** are the actual machine instructions for reading/writing the registers

The `syscall ()` construct (Pentium3 – kernel 2.6)

- `syscall ()` is implemented within `glibc` (in `stdlib.h`)
- It allows triggering a trap to the kernel for the execution of a generic system call
- The first argument is the system call number
- The other parameters are the input for the system call code
- The actual ASM code implementation of `syscall ()` is targeted and optimized for the specific architecture
- Specifically, the implementation (including the kernel level counterpart) relies on ASM instructions such as `sysenter/sysexit` or `syscall/sysret`, which have been made available starting from Pentium3 processors

An example for gcc version 4.3.3 (Ubuntu 4.3.3-5ubuntu4) – backward-compatible

```
#include <stdlib.h>

#define __NR_my_first_sys_call 333
#define __NR_my_second_sys_call 334

int my_first_sys_call(){
    return syscall(__NR_my_first_sys_call);
}

int my_second_sys_call(int arg1){
    return syscall(__NR_my_second_sys_call, arg1);
}

int main(){
    int x;

    my_first_sys_call();
    my_second_sys_call(x);
}
```

The system call table

- The kernel level system call table is defined in specific files
- As an example, for kernel 2.4.20 and i386 machines it is defined in `arch/i386/kernel/entry.S`
- As another example, for kernel 2.6.xx the table is posted on the file `arch/x86/kernel/syscall_table32.S`
- As another example for kernel 4.15.xx and x86-64 the table pointer is defined in `/arch/x86/entry/syscall_64.c`
- The `.S` files contains pre-processor ASM directives
- Any entry keeps a symbolic reference to the kernel level name of a system call (typically, the kernel level name resembles the one used at application level)
- The above files (or other `.S`) also contains the code block for the dispatcher associated with the kernel access GATE

Table structure

```
ENTRY(sys_call_table)
    .long SYMBOL_NAME(sys_ni_syscall) /* 0 - old "setup()"
system call*/
    .long SYMBOL_NAME(sys_exit)
    .long SYMBOL_NAME(sys_fork)
    .long SYMBOL_NAME(sys_read)
    .long SYMBOL_NAME(sys_write)
    .long SYMBOL_NAME(sys_open) /* 5 */
    .long SYMBOL_NAME(sys_close)
    .....
    .long SYMBOL_NAME(sys_sendfile64)
    .long SYMBOL_NAME(sys_ni_syscall) /* 240 reserved for futex
*/
    .....
    .long SYMBOL_NAME(sys_ni_syscall) /* 252
sys_set_tid_address */
    ←~~~~~ New symbols need to be inserted here
    .rept NR_syscalls-(.-sys_call_table)/4
        .long SYMBOL_NAME(sys_ni_syscall)
    .endr
```

Definition of system call symbols

- For the previous example, the actual system call specification will be

```
.long SYMBOL_NAME(sys_my_first_sys_call)
.long SYMBOL_NAME(sys_my_second_sys_call)
```

- The actual code for the system calls (generally based exclusively on C with compilation directives for the specific architecture) can be included within new modules added to the kernel or within already existing modules
- The actual code can rely on the kernel global data structures and on functions already available within the kernel, except for the case where they are explicitly masked (e.g. masking with `static` declarations external to the file containing the system call)

Compilation directives for kernel side systems calls

- Specific directives are used to make the system call code compliant with the dispatching rules
- **Compliance is assessed on the basis of how the input parameters are passed/retrieved**
- The input parameters passage by convention historically took place via the kernel stack
- The corresponding compilation directive is `asm linkage`
- This directive is now mapped to the current ABI
- Hence for the previous examples we will have the following system call definitions

```
asm linkage long sys_my_first_sys_call() { return 0; }
asm linkage long sys_my_second_sys_call(int x) {
    return ((x>0)?x:-x); }
```

The actual dispatcher (trap driven activation – i386 kernel 2.4)

```
ENTRY(system_call)
    pushl %eax                # save orig_eax
    SAVE_ALL
    GET_CURRENT(%ebx)
    testb $0x02,tsk_ptrace(%ebx) # PT_TRACESYS
    jne tracesys
    cmpl $(NR_syscalls),%eax ← Beware this!!!
    jae badsys
    call *SYMBOL_NAME(sys_call_table)(,%eax,4)
    movl %eax,EAX(%esp) # save the return value
ENTRY(ret_from_sys_call)
    cli                        # need_resched and signals atomic test
    cmpl $0,need_resched(%ebx)
    jne reschedule
    cmpl $0,sigpending(%ebx)
    jne signal_return
restore_all:
    RESTORE_ALL
```

Manipulating the CPU snapshot in the stack

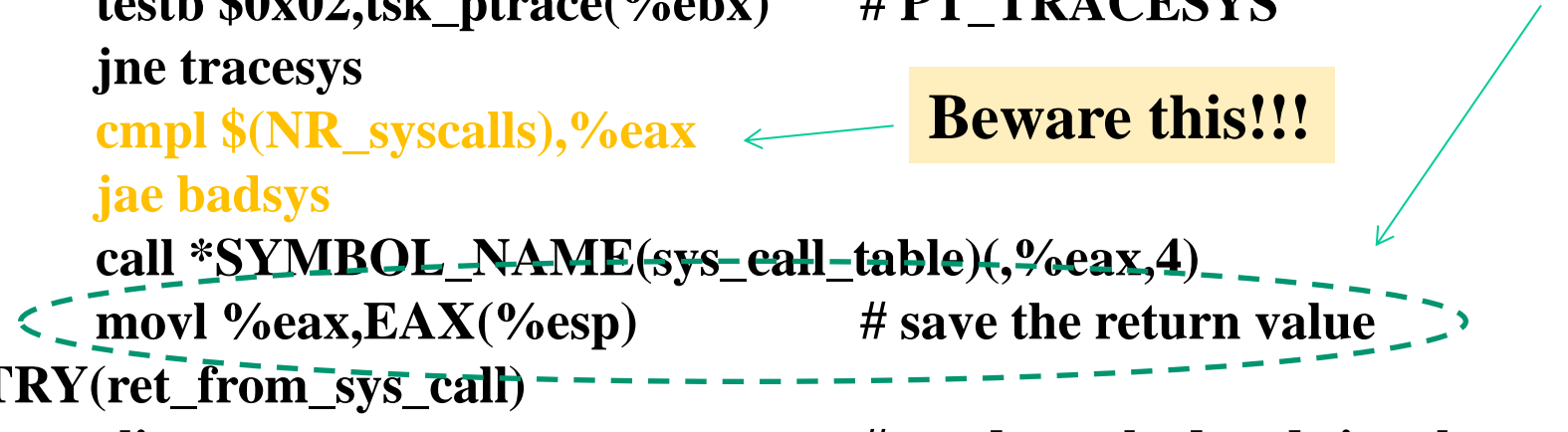

The actual dispatcher (syscall driven activation – kernel 2.4)

ENTRY(system_call)

```
swaps
movq    %rsp,PDAREF(pda_oldrsp)
movq    PDAREF(pda_kernelstack),%rsp
sti
SAVE_ARGS 8,1
movq    %rax,ORIG_RAX-ARGOFFSET(%rsp)
movq    %rcx,RIP-ARGOFFSET(%rsp)
GET_CURRENT(%rcx)
testl  $PT_TRACESYS,tsk_ptrace(%rcx)
jne  tracesys
cmpq  $__NR_syscall_max,%rax
ja  badsys
movq    %r10,%rcx
call   *sys_call_table(,%rax,8) # XXX:
movq    %rax,RAX-ARGOFFSET(%rsp)
.globl ret_from_sys_call
```

ret_from_sys_call:

sysret_with_reschedule:

```
GET_CURRENT(%rcx)
cli
cmpq    $0,tsk_need_resched(%rcx)
jne  sysret_reschedule
cmpl    $0,tsk_sigpending(%rcx)
jne  sysret_signal
```

sysret_restore_args:

.....

#define PDAREF(field) %gs:field

Part of the stack switch work originally done via firmware is moved to software

rip relative

Beware this!!!

User vs kernel GS segment

SWAPGS — Swap GS Base Register

Opcode	Instruction	Op/En	64-Bit Mode	Compat/Leg Mode	Description
0F 01 F8	SWAPGS	ZO	Valid	Invalid	Exchanges the current GS base register value with the value contained in MSR address C0000102H.

Instruction Operand Encoding

Op/En	Operand 1	Operand 2	Operand 3	Operand 4
ZO	NA	NA	NA	NA

Description

SWAPGS exchanges the current GS base register value with the value contained in MSR address C0000102H (IA32_KERNEL_GS_BASE). The SWAPGS instruction is a privileged instruction intended for use by system software.

When using SYSCALL to implement system calls, there is no kernel stack at the OS entry point. Neither is there a straightforward method to obtain a pointer to kernel structures from which the kernel stack pointer could be read. Thus, the kernel cannot save general purpose registers or reference memory.

By design, SWAPGS does not require any general purpose registers or memory operands. No registers need to be saved before using the instruction. SWAPGS exchanges the CPL 0 data pointer from the IA32_KERNEL_GS_BASE MSR with the GS base register. The kernel can then use the GS prefix on normal memory references to access kernel data structures. Similarly, when the OS kernel is entered using an interrupt or exception (where the kernel stack is already set up), SWAPGS can be used to quickly get a pointer to the kernel data structures.

The IA32_KERNEL_GS_BASE MSR itself is only accessible using RDMSR/WRMSR instructions. Those instructions are only accessible at privilege level 0. The WRMSR instruction ensures that the IA32_KERNEL_GS_BASE MSR contains a canonical address.

... moving to kernel 4.xx

Snippet taken from

https://github.com/torvalds/linux/blob/master/arch/x86/entry/entry_64.S

```
ENTRY(entry_SYSCALL_64)
    UNWIND_HINT_EMPTY
    /*
     * Interrupts are off on entry.
     * We do not frame this tiny irq-off block with TRACE_IRQS_OFF/ON,
     * it is too small to ever cause noticeable irq latency.
     */

    swapgs
    /*
     * This path is only taken when PAGE_TABLE_ISOLATION is disabled so it
     * is not required to switch CR3.
     */
    movq    %rsp, PER_CPU_VAR(rsp_scratch)
    movq    PER_CPU_VAR(cpu_current_top_of_stack), %rsp

    /* Construct struct pt_regs on stack */
    pushq   $__USER_DS                /* pt_regs->ss */
    pushq   PER_CPU_VAR(rsp_scratch)  /* pt_regs->sp */
    pushq   %r11                      /* pt_regs->flags */
    pushq   $__USER_CS                /* pt_regs->cs */
    pushq   %rcx                      /* pt_regs->ip */
GLOBAL(entry_SYSCALL_64_after_hwframe)
    pushq   %rax                      /* pt_regs->orig_ax */

    PUSH_AND_CLEAR_REGS rax=$-ENOSYS

    TRACE_IRQS_OFF

    /* IRQs are off. */
    movq    %rax, %rdi
    movq    %rsp, %rsi
    call    do_syscall_64              /* returns with IRQs disabled */
    TRACE_IRQS_IRETQ                  /* we're about to change IF */

    /*
     * Try to use SYSRET instead of IRET if we're returning to
     * a completely clean 64-bit userspace context. If we're not,
     * go to the slow exit path.
     */
```

Here we pass control to a C-stub, not to the actual system call

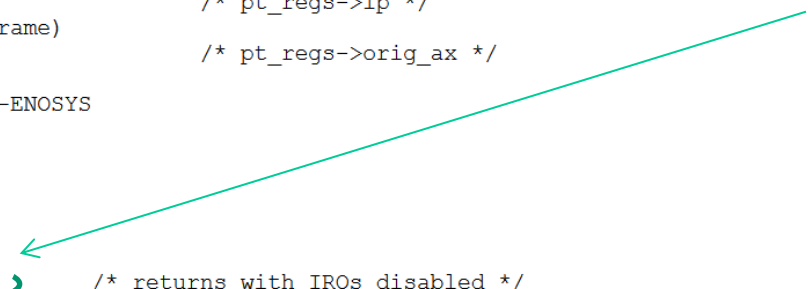

Snippet taken from

<https://github.com/torvalds/linux/blob/master/arch/x86/entry/common.c>

```
271  #ifdef CONFIG_X86_64
272  __visible void do_syscall_64(unsigned long nr, struct pt_regs *regs)
273  {
274      struct thread_info *ti;
275
276      enter_from_user_mode();
277      local_irq_enable();
278      ti = current_thread_info();
279      if (READ_ONCE(ti->flags) & _TIF_WORK_SYSCALL_ENTRY)
280          nr = syscall_trace_enter(regs);
281
282      /*
283       * NB: Native and x32 syscalls are dispatched from the same
284       * table. The only functional difference is the x32 bit in
285       * regs->orig_ax, which changes the behavior of some syscalls.
286       */
287      nr &= __SYSCALL_MASK;
288      if (likely(nr < NR_syscalls)) {
289          nr = array_index_nospec(nr, NR_syscalls);
290          regs->ax = sys_call_table[nr](regs);
291      }
292
293      syscall_return_slowpath(regs);
294  }
295  #endif
```

Wrong-speculation
cannot rely on arbitrary
sys-call indexes!!!!

Also, from kernel 4.17
the system call table
entry no longer points
to the actual system
call code, rather to
another wrapper that
masks from the stack
non-useful values

Overall

- For more security-oriented implementations we have
 - ✓ More strict checks and manipulation of the user provided information before any action is taken
 - ✓ A more layered architecture for better decoupling user/kernel information flows
- The latter point has reflection on programming aspects since for, e.g., Kernel 4.17 the kernel-side creation of a new system call should be based on kernel level macros for implementing a stub-based execution of the native system-call code
- These macros are `SYSCALL_DEFINE0`, `SYSCALL_DEFINE1`, `SYSCALL_DEFINE2`, `SYSCALL_DEFINE3`

Actual usage/effect of kernel-side sys-call macros

- The `SYSCALL_DEFINE2` example (still representative of other macros)

```
SYSCALL_DEFINE2(name, param1type, param1name, param2type, param2name){  
    actual body implementing the kernel side system call  
}
```



The macro creates a function

`sys_name` (aliased by `Sys_name`) or

`__x86_sys_name` from kernel 4.17

In 4.17 this function passes only the requested values (i.e. `param1name` and `param2name`) to the actual function

related to the above specified body - such a function has

now name `__se_sys_name`

Virtual Dynamic Shared Object (VDSO)

- Kernel also setups system call entry/exit points for user processes
- Kernel creates a single page (or a few) in memory and attaches it to all processes' address space when they are loaded into memory.
- This page contains the actual implementation of the system call entry/exit mechanism
- For i386 the definition of this page can be found in the file `/usr/src/linux/arch/i386/kernel/vsyscall-sysenter.S`
- Kernel calls this page **virtual dynamic shared object (VDSO)**
- Originally exploited for making the fast system call path available (in relation to a few services)

VDSO and the address space

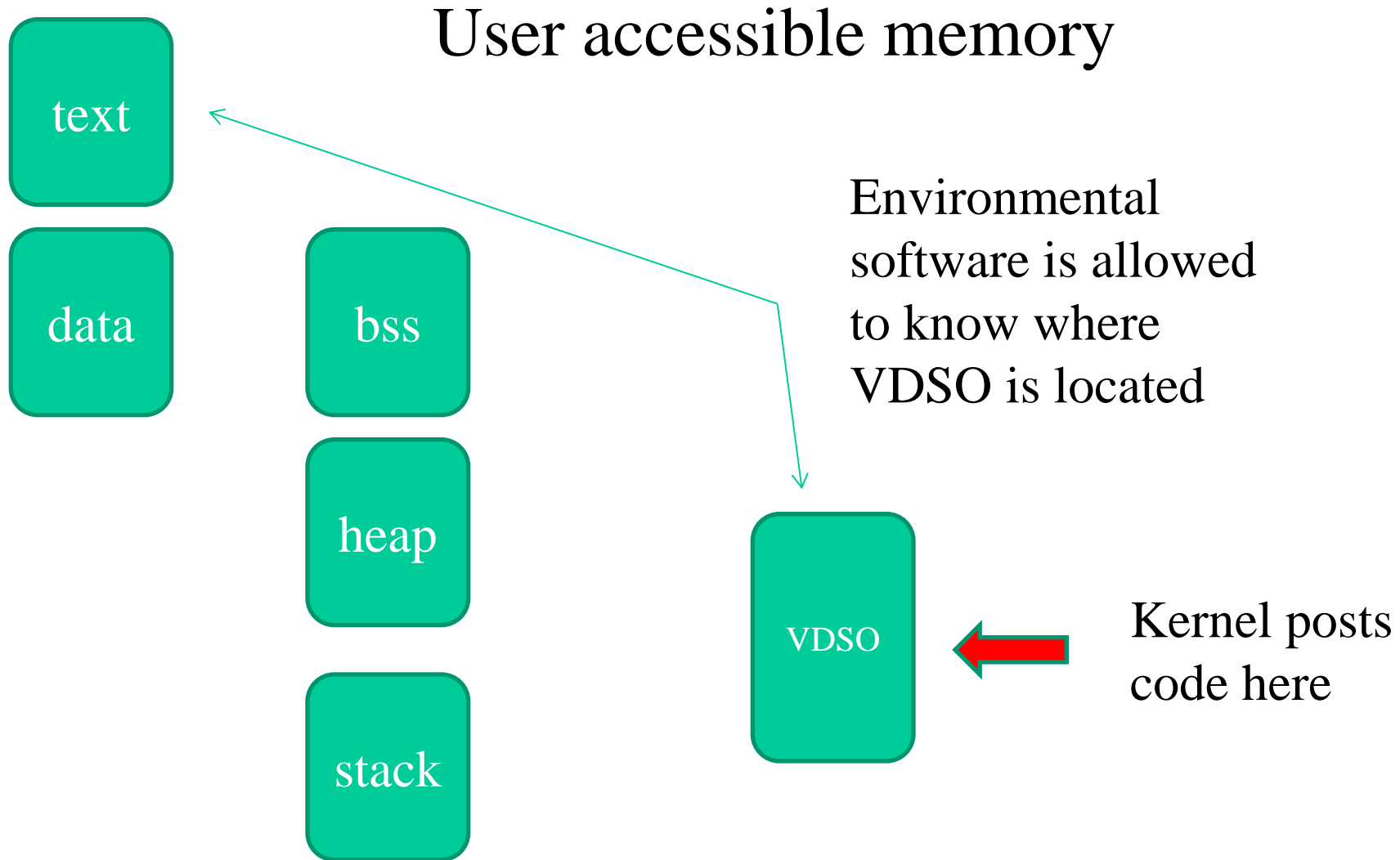

Application exposed facilities

SYNOPSIS

```
#include <sys/auxv.h>
```

```
void *vdso = (uintptr_t) getauxval(AT_SYSINFO_EHDR);
```

DESCRIPTION

The "vDSO" (virtual dynamic shared object) is a small shared library that the kernel automatically maps into the address space of all user-space applications. Applications usually do not need to concern themselves with these details as the vDSO is most commonly called by the C library. This way you can code in the normal way using standard functions and the C library will take care of using any functionality that is available via the vDSO.

The actual VDSO

```
==> dd if=/proc/self/mem of=linux-gate.dso bs=4096 skip=1048574
1+0 records in
1+0 records out
```

```
==> objdump -d --start-address=0xffffe400 --stop-address=0xffff
ffffe400 <__kernel_vsyscall>:
ffffe400:      51          push    %ecx
ffffe401:      52          push    %edx
ffffe402:      55          push    %ebp
ffffe403:      89 e5       mov     %esp,%ebp
ffffe405:      0f 34      sysenter
...
ffffe40d:      90          nop
ffffe40e:      eb f3      jmp     fffffe403 <__kern
ffffe410:      5d          pop     %ebp
ffffe411:      5a          pop     %edx
ffffe412:      59          pop     %ecx
ffffe413:      c3          ret
```

The kernel level target is **ENTRY(sysenter_entry)**

Performance effects

- The VDSO exploits flat (linear) addressing proper of operating system memory managers in order to bypass segmentation and the related operations
- It therefore reduces the number of accesses to memory in order to support the change to kernel mode
- Studies show that the reduction of clock cycles for system calls can be of the order of 75%
- This is in the end typical for any usage of the fast system call path

The current picture

- VDSO is now used to replace the old facilities supported via the **vsyscall** section, say support for specific system calls (e.g. query system calls such as `gettimeofday()`)
- VDSO is randomized (in terms of positioning into the address space) so security gets increased
- The system call mechanism in the wide, which relies on `sysenter/syscall` and `sysexit/sysret`, is in charge of the dynamic linker (`ld-linux.so`)

Back to the coexistence of slow and fast system call paths

- **Slow path**

- ✓ Still based on `int 0x80`
- ✓ Still accessing IDT/GDT (which is the reason why the target entry still requires to be populated)
- ✓ The kernel level system call dispatcher accesses the i386 system call table

- **Fast path**

- ✓ Base on the `syscall` instruction (no IDT/GDT access)
- ✓ The kernel level dispatcher (different from the previous one) accesses the x86-64 system call table

Kernel software organization

- About the 80-90% of the actual code for system calls is embedded within a few main portions of the kernel archive
- These are contained in the following directories
 - `kernel` (process and used management)
 - `mm` (basic memory management)
 - `ipc` (interprocess communication management)
 - `fs` (virtual file system management)
 - `net` (network management)

Kernel compiling

- You can exploit **make**
- It executed a set of tasks (compilation, assembly and linking tasks) which are specified via a `Makefile`
- This file can specify differentiated actions to be done (possibly exhibiting dependencies) which are described within a field called **target**
- Each action can be specified by the following syntax:

```
action-name: [ dependency-name ] * {new-line}
{tab} action-body
```

- Further, we can define variables via the syntax:

```
variable-name = value
```

- Any variable can be accessed via the syntax:

```
$(variable-name)
```

Standard compilation steps (old style)

1. **make config**

this triggers a configuration script which is used for tailoring compilation to the specific machine and user needs

2. **make dep**

which determines the software modules dependencies

3. **make bzImage**

which creates a bootable image of the kernel and logs it as

```
arch/i386/boot/bzImage
```

Standard compilation steps (current tyle)

make config (or menuconfig)

make

make modules

make modules_install (ROOT)

make install (ROOT)

mkinitrd (or mkinitramfs) -o initrd.img-<vers> <vers>

update-grub

OR

grub-mkconfig -o /boot/grub/grub.cfg (ROOT)

About 'config'

- The possibilities
 - **allyesconfig** (likelihood of conflicting modules)
 - **allnoconfig** (likelihood of non-sufficient services in the kernel image)
 - Answer to the individual questions you may be asked for
 - Retrieve a good configuration file (depending on you machine/settings) on the web
 - Reuse the configuration files(s) you find in the **/boot** directory of your root file system (likely works when recompiling the same kernel version you already have)

Role of initrd

- It is a RAM disk
- It can be (temporary) mounted as the root file system and programs can be run from it
- A different root file system can be then mounted from a different device
- The previous root (from initrd) can then be moved to a directory and can be subsequently unmounted
- With initrd system startup can occur in two phases
 - the kernel initially comes up with a minimum set of compiled-in drivers
 - additional modules are loaded from initrd

Step effects

make config (or menuconfig)

make

make modules

make modules_install (ROOT) (writes into /lib/modules)

make install (ROOT) (writes into /boot: the kernel image, the system map and the config file)

update-grub

OR

grub-mkconfig -o /boot/grub/grub.cfg (ROOT)

“Extended” Kernel compilation (up to 2.4)

- Makefile updates
 1. setting of the EXTRAVERSION variable (non-mandatory)
 2. update of the CORE_FILES variable such in a way to include the directory that contains the added C files and to specify the object file name targeted by the compilation
 3. update the SUBDIRS variable so to include the new directory
- Put a specific Makefile within the directory that contains the source code to be compiled, which should be structured as

```
O_TARGET := object-file-name.o
export-objs := list of obj to be exported
obj-y := C files list (marked with .o)
include $(TOPDIR)/Rules.make
```

“Extended” Kernel compilation (from 2.4)

- Makefile updates
 1. setting of the `EXTRAVERSION` variable (non-mandatory)
 2. use `obj-` directive to add a file or a directory into the compilation tree
 3. the addition is within already available makefiles (or new ones)

Kernel anatomy: the systems map

- It contains the symbols and the corresponding virtual memory reference (as determined at compile/link time – beware randomization) for:
 - Kernel functions (steady state ones)
 - Kernel data structures
- Each symbol is also associated with a tag that defines the ‘storage class’ as determined by the compiling process
- As an example, 'T' usually denotes a global (non-static but not necessarily exported) function, 't' a function local to the compilation unit (i.e. static), 'D' global data, 'd' data local to the compilation unit. 'R' and 'r' same as 'D'/'d' but for read-only data

System map applications

- Kernel debugging
- Kernel run-time hacking
- The system map is also (partially) reported by the (pseudo) file `/proc/kallsym`
- The latter is exploited for run-time kernel ‘hacking’ via the modules’ technology

Just an example

2.6.5-7.282-smp #1 SMP i686 i686 i386 GNU/Linux

c03a8a00 D sys_call_table



Read/write data

2.6.32-5-amd64 #1 SMP x86_64 GNU/Linux

ffffffff81308240 R sys_call_table



Read-only data